



Volker Hinrichsen
Metal-Oxide Surge Arrester

1st Edition

Fundamentals

SIEMENS



Foreword

This is the first part of a two-part handbook on high-voltage metal-oxide surge arresters.

Part 1: Fundamentals covers the functioning, construction and the layout of the metal-oxide surge arresters. This part offers a quick overview without going into great detail. Those sections which have been simplified for the sake of clarity, will contain references to the second part where extensive explanations can be found. To understand the basic principles, however, it is not necessary to read the second part. At the end of the first part arrester layouts will be provided for the most common use of surge arresters – the protection of transformers between phase and ground in an outdoor substation – for various system voltages and the different methods of neutral earthing. Definitions and explanations are given in their shortest possible forms in alphabetical order in the appendix.

Part 2: Selected topics deals with special topics, which are only briefly, or not at all, mentioned in the first part. Included is, for example, the historical development of the surge arresters and a short overview of the last generation of surge arresters before the introduction of the metal-oxide arrester, that is, the gapped silicon-carbide arrester, which is still being extensively used today. The relevant arrester standards and the tests described in these (which are in the process of being revised and expanded) will be introduced, followed by a detailed explanation of the important electrical and mechanical characteristics, constructional details, as well as general and also very special performance characteristics of metal-oxide surge arresters. Discussion of the latest developments in the area of arresters will encompass polymer housed arresters, whose development began between the mid to late 1980's, and which are presently used at levels up to 800 kV. Other topics include the metal-enclosed designs used in gas-insulated switchgear, arresters in series compensation installations, which are connected in parallel to large banks in order to increase the energy absorption capability, and arresters in the HVDC transmission. In addition, special types of applications, such as protection of transformer neutrals or tertiary windings will be dealt with. The conclusion is a chapter on arrester monitoring, which not only deals with existing monitoring procedures, but also those which are being currently developed.

At this time, only part 1 is available. Part 2 is still being worked on. This part is being put together in such a way that current arrester topics can be included at the last moment. So it will be continuously updated and extended.

Despite all this, this first part is now being published. Hopefully in this state it will also be helpful. All those who have helped with tips, critique and discussions are much appreciated. Special thanks to Ms. Jennifer Singer, who provided the English translation. This English edition incorporates some corrections and additions to the German edition, which was published in July 2000. Moreover, it has been updated with information from more recently published standards. Further critique and thoughts on improving this handbook continue, as always, to be welcome.

Berlin, July 2001

Siemens AG
PTD H 4
13623 Berlin
Germany

arrester@siemens.de

© Siemens AG 2001

Contents

Foreword.....	1
Contents.....	3
Tasks and Operating Principles of Metal-Oxide Arresters.....	5
Constructive Design of MO Arresters.....	17
Configuring MO Arresters.....	33
Choosing the Continuous Operating Voltage and the Rated Voltage.....	35
Selecting the Nominal Discharge Current.....	38
Selecting the Line Discharge Class.....	40
Selection and Review of the Protective Levels.....	44
Selecting the Housing.....	47
Service Conditions.....	54
Examples.....	57
Example 1: "Solidly earthed neutral 66-kV-system".....	58
Example 2: "Resonant earthed neutral 110-kV-system".....	60
Example 3: "Solidly earthed neutral 220-kV-system".....	62
Example 4: "Solidly earthed neutral 380-kV-system; industrial pollution".....	64
Example 5: "Solidly earthed neutral 500-kV-system; special requirements".....	66
Example 6: "Resonant earthed or isolated neutral 20-kV-system".....	68
Example 7: "Solidly earthed neutral 20-kV-system".....	70
Standards.....	73
Literature.....	77
Preview of Part 2 - Selected Topics.....	79
Appendix: MO Arresters in Brief.....	83

Tasks and Operating Principles of Metal-Oxide Arresters

Surge arresters – or short, arresters – constitute an indispensable aid to [insulation coordination](#)¹ in electrical power supply systems. Figure 1 makes this clear. There the voltages which may appear in a high-voltage electrical power system are given in per-unit of the peak value of the highest continuous phase-to-earth voltage², depending on the duration of their appearance.

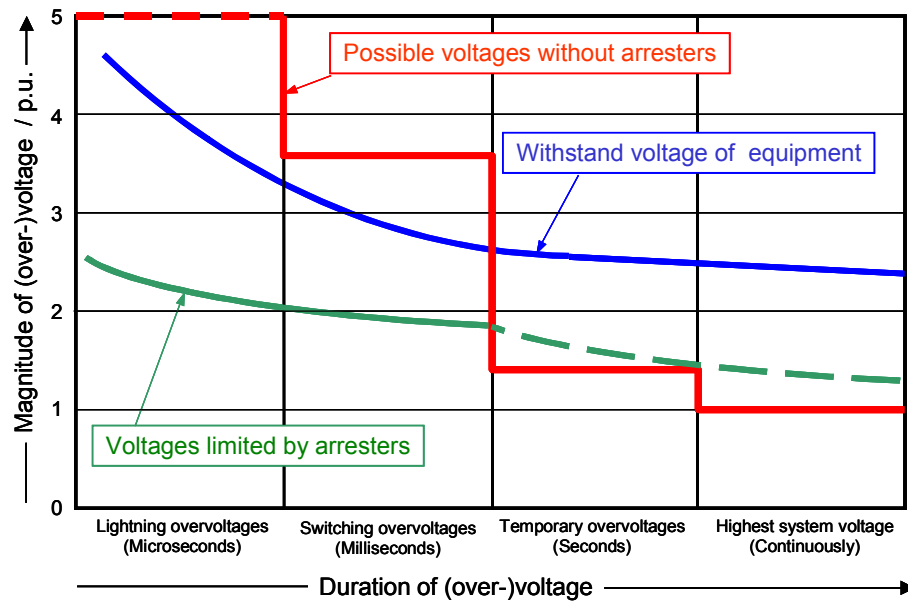

Fig. 1: Schematic representation of the magnitude of voltages and overvoltages in a high-voltage electrical power system versus duration of their appearance (1 p.u. = $\sqrt{2} \cdot U_s / \sqrt{3}$)

The time axis is roughly divided into the range of [lightning overvoltages](#) (microseconds), [switching overvoltages](#) (milliseconds)³, [temporary overvoltages](#) (seconds) – which are commonly cited by the abbreviation "TOV" – and finally the temporally unlimited highest continuous system operation voltage. The voltage or overvoltage which can be reached without the use of arresters, is a value of several p.u. If instead, one considers the curve of the [withstand voltage](#) of equipment insulation, (here equipment means electrical devices such as power transformers) one notices that starting in

¹ Underlined terms are explained in greater detail in the appendix. In the electronic version of the handbook, clicking on the terms will automatically call up the definitions.

² 1 p.u. = $\sqrt{2} \cdot U_s / \sqrt{3}$

³ According to IEC 60071-1, the lightning overvoltages belong to the [fast-front overvoltages](#), and the switching overvoltages belong to the [slow-front overvoltages](#).

the range of switching overvoltages¹, and especially for lightning overvoltages, the equipment insulation cannot withstand the occurring dielectric stresses. At this point, the arresters intervene. While in operation, it is certain that the voltage that occurs at the terminal of the device – while maintaining an adequate safety margin – will stay below the withstand voltage. Arresters' effect, therefore, involves lightning and switching overvoltages².

Even though a great number of arresters which are [gapped arresters](#) with resistors made of [silicon-carbide](#) (SiC), are still in use, the arresters installed today are almost all [metal-oxide \(MO\) arresters](#) without gaps, which means arresters with resistors made of metal-oxide ([metal-oxide or MO resistors](#)). The distinctive feature of an MO resistor is its extremely non-linear [voltage-current or U-I characteristic](#), rendering unnecessary the disconnection of the resistors from the line through serial spark-gaps, as is found in the arresters with SiC resistors. The currents passing through the arrester within the range of possibly applied power-frequency voltages are so small that the arrester almost behaves like an insulator. If, however, surge currents in the kiloampere range are injected into the arrester, such as is the case when lightning or switching overvoltages occur, then the resulting voltage across its terminals will remain low enough to protect the insulation of the associated device from the effects of overvoltage.

In Figure 2, an example is shown of the U-I-characteristic of a typical MO arrester connected between phase and ground in a solidly earthed neutral 420-kV-system³. On the ordinate the voltage peak value is depicted linearly, while on the abscissa current peak values are given in a logarithmic scale. In the depiction, the characteristic extends over a current range of 50 μ A to 50 kA, that is, over nine decades of magnitude. Some important terms are explained below, moving from left to right on the characteristic.

¹ Switching overvoltages do not play an important role in the distribution and the lower-voltage transmission systems, but gain importance with increasing voltage level in the high- and extra-high-voltage systems.

² In general, arresters cannot and are not intended to limit temporary overvoltages. Rather they must be designed to withstand them without sustaining damage.

³ A more detailed U-I-characteristic is depicted in part 2.

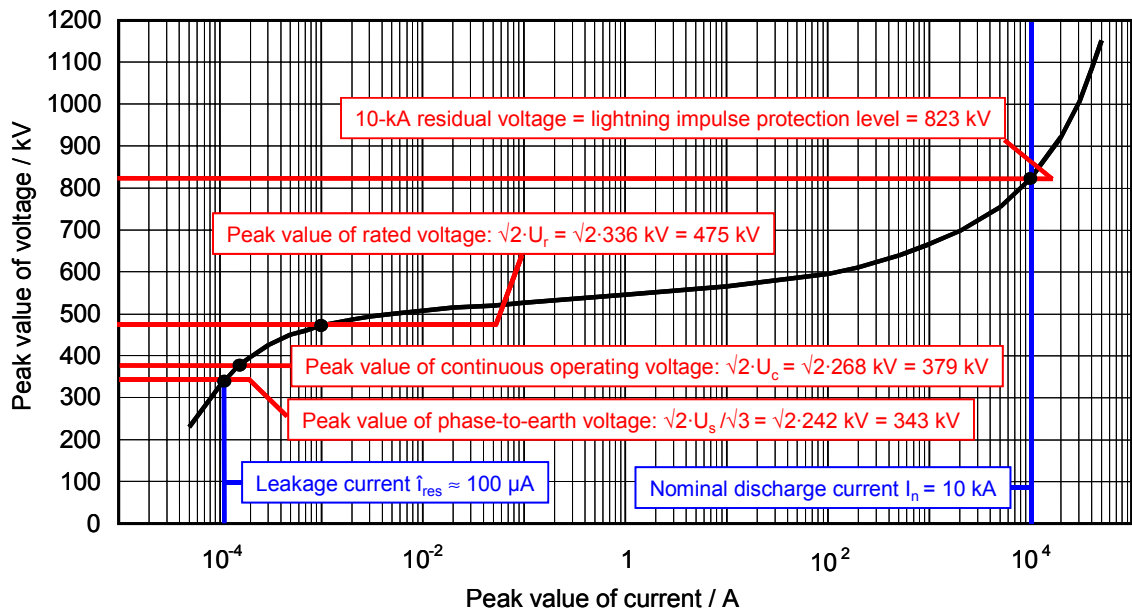

Fig. 2: U-I-characteristic of a typical MO arrester in a solidly earthed neutral 420-kV-system

The power-frequency voltage, while continuously applied to the arrester, is the highest phase-to-earth voltage of the system. In this case the peak value is:

$$\hat{u} = \sqrt{2} \cdot U_s / \sqrt{3} = \sqrt{2} \cdot 420 \text{ kV} / \sqrt{3} = 343 \text{ kV}^1$$

At the same time, the so-called [leakage current](#) flows through the arrester. This consists of a large capacitive and a considerably smaller, resistive component. All in all, the leakage current is – as can also be seen in Figure 3 – for the most part capacitive. In the U-I-characteristic depiction, however, only the resistive component is represented. In this example it is $\hat{i}_{\text{res}} \approx 100 \mu\text{A}$, whereas the total current has a peak value of about 0.75 mA.

The next significant characteristic point is the [continuous operating voltage](#) of the arrester. For this, the formal symbol U_c is used in accordance with the [IEC](#) standards; in Anglo-American circles the term [MCOV](#) (Maximum Continuous Operating Voltage) is customary. This is the power-frequency voltage which the arrester can be operated at, without any type of restrictions. All properties of the arrester which have been demonstrated in the type tests, are valid, assuming that this arrester is energized at a voltage level equivalent to its continuous operating voltage. As is seen in Figure 2, the continu-

¹ It is extremely important when configuring arresters not to start with the [nominal system voltage](#) (in this case, 380 kV), but instead with the [highest voltage of the system](#) U_s , which in most cases is identical to the [highest voltage for equipment](#) U_m . If no information on U_s is available, U_m should be used in order to obtain a stable arrester layout.

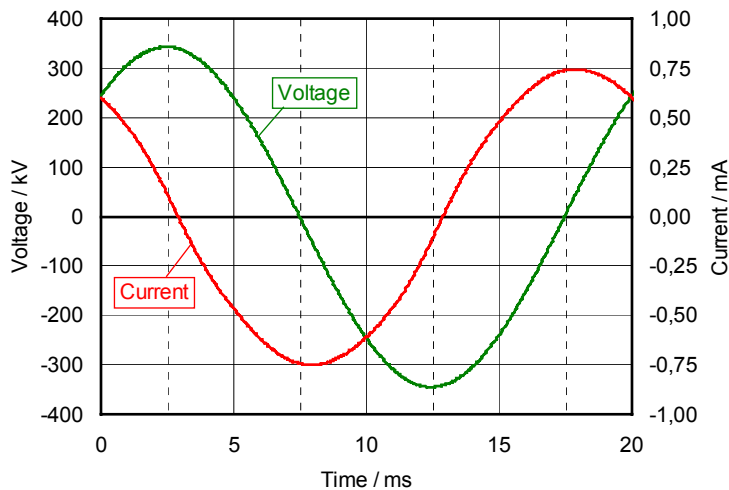

Fig. 3: Applied voltage and leakage current of the sample arrester of Fig. 2 when operated at phase-to-earth voltage ($U_s = 420$ kV, $U_r = 336$ kV)

ous operating voltage is greater than the highest continuously occurring phase-to-earth voltage. An allowance of at least 5% (IEC 60099-5, clause 3.2.1) is recommended. With this, possible harmonics in the system voltage are taken into account. In the chosen example the arrester shows a continuous operating voltage of $U_c = 268$ kV, which is almost 11% above the highest continuous possible phase-to-earth voltage¹.

The name of the next characteristic point is somewhat misleading. The [rated voltage](#) (the symbol: U_r) of a metal-oxide arrester is not, as one might at first assume, a voltage which can be limitlessly applied (that one is the continuous operating voltage mentioned earlier). Instead it characterizes the capability of the arrester to deal with temporary overvoltages in the system. It can only be applied temporarily – for a time period of 10 seconds. Some manufacturers permit a time period of 100 seconds. The characteristic shows that under these conditions there is a leakage current (more precisely, its resistive component) of ca. 1 mA. This would otherwise lead to a significant increase in the temperature of the arrester, but not within a time period of ten or even one hundred seconds. The actual cause of the temporary time limit is the sudden great increase in the temperature and the frequent rise in leakage current (the temperature-dependence of the U-I-characteristic is not shown in the simplified depiction in Figure 2), after, for example, the arrester has diverted a current impulse to the ground (that is, after it had to "operate"). In this case an extensive application of the rated voltage could render the arrester

¹ Choosing a higher continuous operating voltage than is minimally required has a beneficial effect on the stability of an arrester in continuous operation; see the section called "Configuring MO Arresters".

incapable of recooling; instead it would become [thermally unstable](#) and would continually heat up until it reached self-destruction (so-called [thermal runaway](#)).

The rated and continuous operating voltage of an arrester are directly related to each other. The value of this ratio is almost always 1.25, with only a few exceptions, and is not manufacturer-dependent¹. As a result in the chosen example, the rated voltage is $U_r = 1.25 \cdot U_c \approx 336 \text{ kV}^2$.

This concludes the description of the part of the U-I-characteristic curve relevant to power-frequency voltage. The curve then continues into an area in which even minimal voltage increases lead to a significant rise in the current. It is reserved for transient events within a time range of milli- and microseconds, in other words, for switching and lightning overvoltages. Applying power-frequency voltage in this area of the characteristic would destroy the arrester in a fraction of a second.

The characteristic in the region of currents greater than about 100 A describes the protective characteristic of the arrester. Its most important parameter is the [lightning impulse protective level](#) depicted in Figure 2. This depicts the voltage which drops across the arrester terminals when the [nominal discharge current](#) flows through the arrester. The aforementioned is a [lightning current impulse](#) of a standardized shape, whose amplitude is assigned to different classes from 1.5 kA to 20 kA, according to the IEC standard 60099-4. For high-voltage arresters (in systems with $U_s \geq 123 \text{ kV}$) only classes 10 kA and 20 kA are common. The nominal discharge current divulges little about the properties of the arrester. Two "10-kA-arresters" can have very different properties. When selecting an arrester the nominal discharge current therefore cannot be considered on its own. For the example in Figure 2, a 10-kA-arrester was selected. The statement "lightning impulse protective level = 823 kV" means the following: a voltage at a maximum of 823 kV drops across the terminals when impressing a lightning current impulse of 8 μs of [virtual front time](#), 20 μs of [virtual time to half-value on the tail](#) and a peak value of 10 kA. These relationships are likewise depicted in Figure 4.

A lightning impulse protective level of 823 kV means that the peak value of the terminal voltage during a discharge, starting from normal operation at phase-to-earth volt-

¹ Nevertheless there is no direct physical explanation for this relationship. It was found to be purely empirical.

² When rounding off in these calculations, deviations of up to 1 kV can occur. See the layout examples at the end of the handbook.

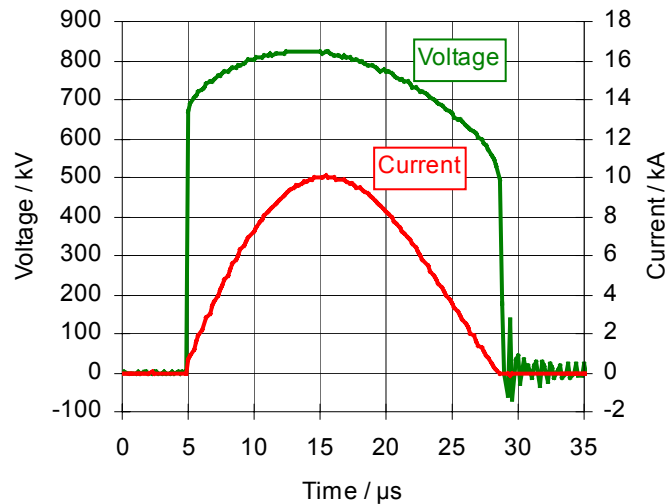

Fig. 4: Residual voltage of the sample arrester of Fig. 2 ($U_r = 336$ kV) at nominal discharge current ($I_n = 10$ kA)

age, increases by a factor of about 2.4 (823 kV divided by 343 kV), while at the same time the current amplitude increases by eight decades of magnitude (from 100 μ A to 10 kA). This substantiates the extreme non-linearity of the arrester's voltage-current-characteristic.

Equipment in the 420-kV-system normally has a [standard lightning impulse withstand voltage](#)¹ of 1425 kV. This (test voltage) value, however, is not allowed to ever be attained in practice. In accordance with the application guide on insulation coordination, IEC 60071-2, the highest occurring voltage in the case of a non-self-restoring insulation in operation should stay below this value by a factor of 1.15, that is, not exceed 1239 kV. Nevertheless, the lightning impulse protective level of 823 kV of the sample arrester seems at first to offer more than enough protection. It should, however, be noted that this value represents a *voltage across the arrester terminals*, caused by the flow of an ideal standardized test current at the same level as the arrester's nominal discharge current. Three significant causes can allow the voltage at *the terminals of the equipment to be protected* to take on a considerably higher value:

a) **Traveling wave processes:** Rapidly increasing overvoltages spread in the form of [traveling waves](#) on the line. In those places where the [surge impedance](#) of the line changes, refraction and reflection occur. Especially, a voltage wave will be totally

¹ Frequently BIL – basic lightning impulse insulation level – is mentioned in this context. This term from the US standards is, however, not defined in the IEC standards (see the comment on [BIL](#) in the appendix).

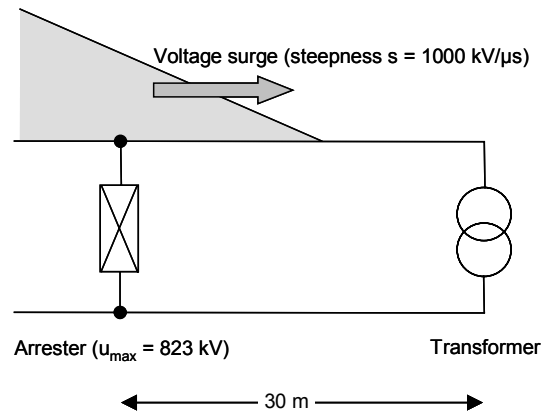

Fig. 5: Simplified arrangement to illustrate the protective zone of an arrester (explanation see text)

positively reflected when reaching an unterminated end of the line. The voltage level at every instant and at every point on the line results from the sum of the different instantaneous values of each individual voltage wave. Thus, at the terminated end this value will be doubled. A connected transformer appears similar to an unterminated end since its winding inductivity for rapid functions exhibits a great resistance compared with the surge impedance of the line. The consequences of this are explained by means of a simplified example (Figure 5). An overvoltage surge with a front steepness of $1000 \text{ kV}/\mu\text{s}$ runs towards a transformer. The propagation of such a surge on an overhead line, as in this example, occurs at the speed of light, that is at $300,000 \text{ km/s}$ or $300 \text{ m}/\mu\text{s}$. It is assumed that this arrester is an ideal one, which behaves like an insulator up to a voltage level of 823 kV , while higher overvoltages are limited to exactly 823 kV . The overvoltage surge first passes by the arrester and reaches the transformer $0.1 \mu\text{s}$ later, which is the propagation time on the 30 m long stretch between the arrester and the transformer. At this time the voltage at the arrester has reached a value of $1000 \text{ kV}/\mu\text{s} \cdot 0.1 \mu\text{s} = 100 \text{ kV}$. Thus, the arrester is still behaving like an insulator. At the transformer the arriving surge is reflected. That is why an additional voltage surge, with the same shape and polarity, runs back from there. The superimposition of both surges causes the voltage at the transformer to increase at double the speed, thus at $2000 \text{ kV}/\mu\text{s}$. Another $0.1 \mu\text{s}$ means a voltage here of 200 kV . At the same time the reflected surge has reached the arrester, whose voltage up to this point in time has increased at the original rate of rise and, therefore, in the meantime, has also reached a voltage level of 200 kV . From now on the original and the reflected surges are superimposed on the arrester, and the voltage increases at a steepness of $2000 \text{ kV}/\mu\text{s}$ not only at the transformer, but also here. The situation at the arrester does not change until the voltage at its terminals has reached the limiting value of 823 kV . In accordance with the starting assumption, a higher value cannot

be taken on. According to the rules of traveling wave processes, this can only be reached if a negative voltage surge with a steepness of 2000 kV/ μ s spreads out to both sides from the arrester. The superimposition of the original surge on that which was reflected from the transformer, and which is now again reflected from the arrester, causes the voltage at the arrester to maintain a constant value of 823 kV. Another 0.1 μ s passes – the propagation time needed for the 30 m stretch between the arrester and the transformer – before the negative surge reflected from the arrester reaches the transformer. During this time, however, the voltage there has already increased by 200 kV. Therefore, it already has a value of 1023 kV. Only now the arrester makes itself "noticeable" at the transformer and reduces the attained voltage¹. The example shows that the voltage at the equipment to be protected can be considerably higher than that found at the arrester. Exactly how high depends mostly upon the distance between the arrester and the device to be protected, and on the front steepness of the voltage surge (the same example with double the distance and an only 10% greater rate of increase for the voltage would cause the given maximum permissible voltage of 1239 kV to already be exceeded at the transformer). This example makes it clear that the arrester has only a limited local [protective zone](#)!

- b) **Inductive voltage drops:** The current path shown in Figure 6 of the discharge current from the termination of the arrester to the overhead line conductor, down to the effective earth, is ten meters long. At a specific value of 1 μ H per meter (the typical inductance of a stretched conductor at a great distance from other live or earthed parts) its inductivity is 10 μ H. In extreme cases a steepness of 10 kA/ μ s of a lightning current impulse can be expected. Under these conditions the inductive voltage drop of the shown arrangement is

$$u = L \cdot \frac{di}{dt} = 10 \mu\text{H} \cdot 10 \text{kA} / \mu\text{s} = 100 \text{kV}.$$

This does not necessarily appear simultaneously at the peak value of the arrester residual voltage. However, this value of 100 kV demonstrates the order of magnitude of possible inductive voltage drops which can superimpose the arrester residual voltage.

¹ Since the arriving negative surge is reflected again in its full magnitude, not only does the voltage limit of 1023 kV result after the superimposition of all the partial surges at the transformer, but also a voltage reduction. If one carries out the calculation in the manner described, the transformer takes on an oscillating voltage with a maximum value of 1023 kV. In practice, the amplitude and shape of the oscillation are damped by various influences not considered here.

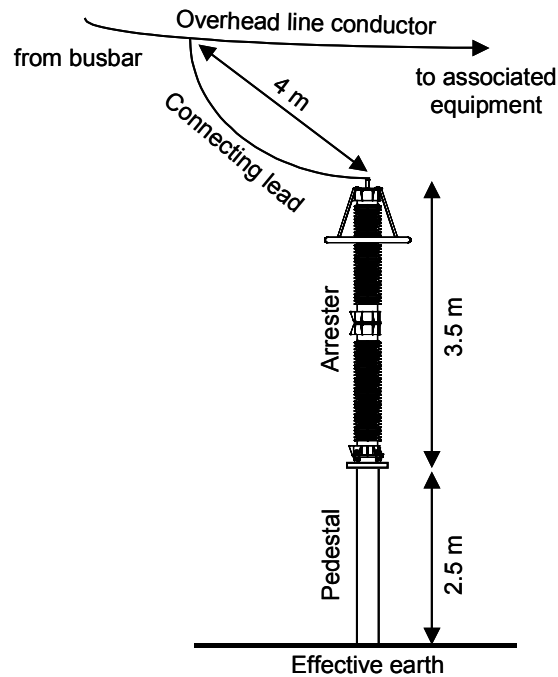

Fig. 6: Typical arrangement of an arrester in a 420-kV substation

- c) **Discharge currents higher than the arrester nominal discharge current:** the protective level of the arrester is defined as its residual voltage at the nominal discharge current. Higher discharge currents may also occur. The arrester can withstand this undamaged, but it results in a higher residual voltage across its terminals depending on the shape of the U-I-characteristic.

Thus, when choosing an arrester protective level, certain details must be considered, such as the distance between the arrester and the device to be protected, the particular substation configuration or the typical overvoltage stress in the system. Normally a factor of at least 1.4 between the standard lightning impulse withstand voltage of the device to be protected and the lightning impulse protective level of the arrester leads to safe protection against fast-front overvoltages. In problematic cases, however, for example when [very-fast-front overvoltages](#) are to be expected, or when there are unusually great distances between the arrester and the device to be protected, the protective effect must be individually checked by means of a detailed calculation.

Not only is configuring for stable continuous operation (U-I-characteristic in the leakage current range) and choosing sufficiently low protective levels (U-I-characteristic curve in the high current range) necessary, but the arrester must also possess the necessary [energy absorption capability](#) for each individual application. In the process, two different aspects must be considered:

The energy which is instantaneously injected during a single discharge is not allowed to exceed a value at which the metal-oxide resistors will be thermo-mechanically overstressed. Thus, one speaks in this context of the [single impulse energy absorption capability](#) of an arrester. Energy which is injected within only a few micro- or milliseconds causes extreme, sudden temperature rises associated with excessive tensile and compressive forces acting on the MO resistor ceramic. This can lead to fine cracks or even cause the resistors to break. The effect is supported by the smallest inhomogeneities in the ceramic of the MO resistors, which despite the highly developed manufacturing technology are basically unavoidable. They may cause locally limited overheating of the ceramic in case of extremely high current and energy densities, respectively. Since the heat cannot spread fast enough into the surrounding material, additional thermo-mechanical stresses occur. By similar means hot channels may develop at locations of inhomogeneities, leading to electrical puncturing of the resistor. The single impulse energy absorption capability is thus a characteristic property of the metal-oxide resistor inserted in the arrester, independent of the rest of the arrester design. It is specified by the manufacturer with a sufficient safety margin to the actual limits.

Totally different contexts are valid for the [thermal energy absorption capability](#). This is defined as the maximum level of energy injected into the arrester, at which it can still cool back down to its normal operating temperature. Figure 7 illustrates this problem: the electrical power loss resulting from the continuously applied power-frequency voltage is temperature-dependent. It rises overproportionally as the temperature increases. On the other hand, because of its design, the arrester can only dissipate a certain limited amount of heat into the surroundings. Indeed, this heat-flow value also rises with the

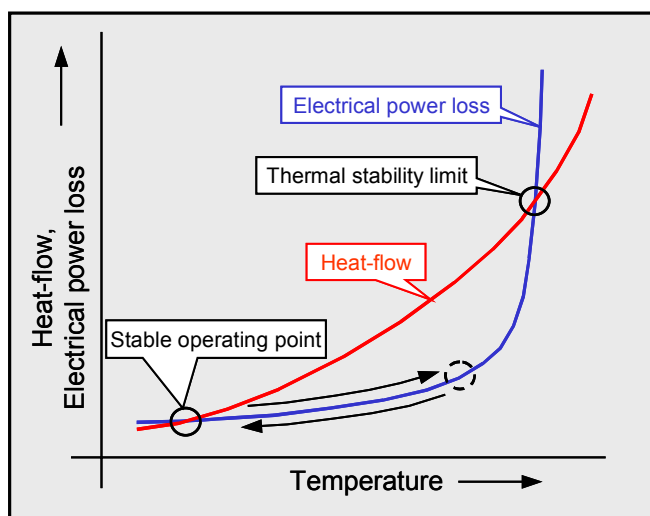

Fig. 7: Explanation of the thermal stability

temperature, however, not nearly as much as the electrical power loss does. Both power curves have two common points of intersection. The left one is a stable operating point. At this point exactly as much heat is dissipated to the outside, as is produced in the MO resistor: a thermal balance prevails. A discharge operation disturbs this balance. The energy which is introduced increases the temperature rapidly, and the operating point moves to the right on the power loss curve, as is shown with an arrow in Figure 7. As long as the right point of intersection of the curves is not reached, the heat generated by electrical power loss can easily be dissipated, and the arrester can return to the stable operating point. If, however, the right point of intersection is reached or exceeded, then cooling is no longer possible. The arrester then becomes thermally unstable and heats up until it self-destroys. This point of intersection, therefore, represents the [thermal stability limit](#). The thermal energy absorption capability is specified in such a way that the related temperature increase brings the arrester to a temperature which exhibits an adequate safety margin to the thermal stability limit. The actual thermal stability limit depends on the overall arrester design and has a value of typically between 170 °C and 200 °C.

Both definitions of the energy absorption capability cited above are not specified in standards. According to the decisive IEC standard 60099-4 on metal-oxide surge arresters without gaps, the energy absorption capability is only described by means of, what is known as, the [line discharge class](#). Its definition is, however, complicated. Indirectly it is about the thermal energy absorption capability. This will be dealt with more thoroughly later in this chapter.

With respect to the energy absorption capability, it must finally be mentioned that arresters normally are designed to divert to the ground only a fraction of the charge which is introduced to the overhead line conductor as a result of a direct lightning stroke. In this case, it is assumed that the overvoltage which occurs on the overhead line conductor, will cause a flashover of one or more line insulators. The greatest part of the charge is thus diverted through the flashover channels towards the ground. Only overvoltages limited to the insulator flashover voltage with the appropriately reduced charge content will finally reach the stations (switchyards, transformer substations), and only these must further be limited by the arresters in the station and their contained charge further diverted to the ground.

In medium-voltage distribution systems the arresters are widely spread over the whole network as they are normally directly arranged either, for instance, at the pole-mounted transformers, or at the cable terminations. Once in a while, lightning may hit the line so closely to the arrester, that it is only relieved a little or not at all by insulators

flashing over. This is known as a [nearby direct lightning stroke](#) and a common cause for arrester failures in these systems. Attempts to avoid this in high-voltage transmission systems are made by improving the shielding of the line, for example, by installing a second overhead shield wire next to the station. That is why nearby direct lightning strokes almost never occur in conjunction with high-voltage station arresters. As a result their failure rate is about one order of magnitude lower than that of distribution arresters¹.

¹ See part 2 for further information.

Constructive Design of MO Arresters

This chapter describes the basic constructive design of MO arresters. From the many possible ways to construct an arrester, only a few examples have been chosen so that the principle is clear. For more detailed descriptions and information one must refer again to the second part.

The fact that there is no longer any need for serial gaps, which were mandatory for the gapped SiC arresters, has simplified the design of arresters considerably. Certain designs of the polymer housed arresters were in fact impossible to construct until the gapless metal-oxide technique was introduced. As a major progress, MO arresters could be built with only one single effective active element, namely the column of the MO resistors. High demands are, however, made on these MO resistors, as they combine all the functions, which previously had been shared among the different components of the gapped arrester. In this way they have to be ageing resistant while being subjected to constantly applied operating voltage. They must be able to absorb the energy injected during a discharge, and they should subsequently limit the follow current (leakage current) to values small enough for thermally stable operation. As a result, development of the MO resistors and their manufacturing technology – the production of MO resistors is considerably more complicated than that of SiC resistors – are of particularly great importance. A whole chapter is devoted to this in part 2. Only the constructive design of an MO arrester will be dealt with here.

Figure 8 shows the cross section of a [unit](#) of an MO arrester with porcelain housing to be applied in a high-voltage system. The **MO resistor column**, together with the accompanying supporting construction, comprises the actual [active part](#) of the arrester. The column consists of individual MO resistors stacked on top of each other. The MO resistors are almost always produced in a cylindrical form (Figure 9)¹. Their diameter decisively determines the energy absorption and the current carrying capability. It is within a range of about 30 mm when used for distribution systems, and up to 100 mm or more for high- and extra-high-voltage systems and special applications, for which high energy absorption capabilities are required². For especially high demands, active parts

¹ Some manufacturers, especially Japanese ones, also use designs with center holes, forms which are similar to toroids. For low voltage varistors square designs are also common.

² Actually the volume of the MO resistors is the decisive value. But for any given protective level of an arrester the length of the MO resistor column is more or less fixed, so that the energy absorption capability can only be affected by the diameter of the MO resistors.

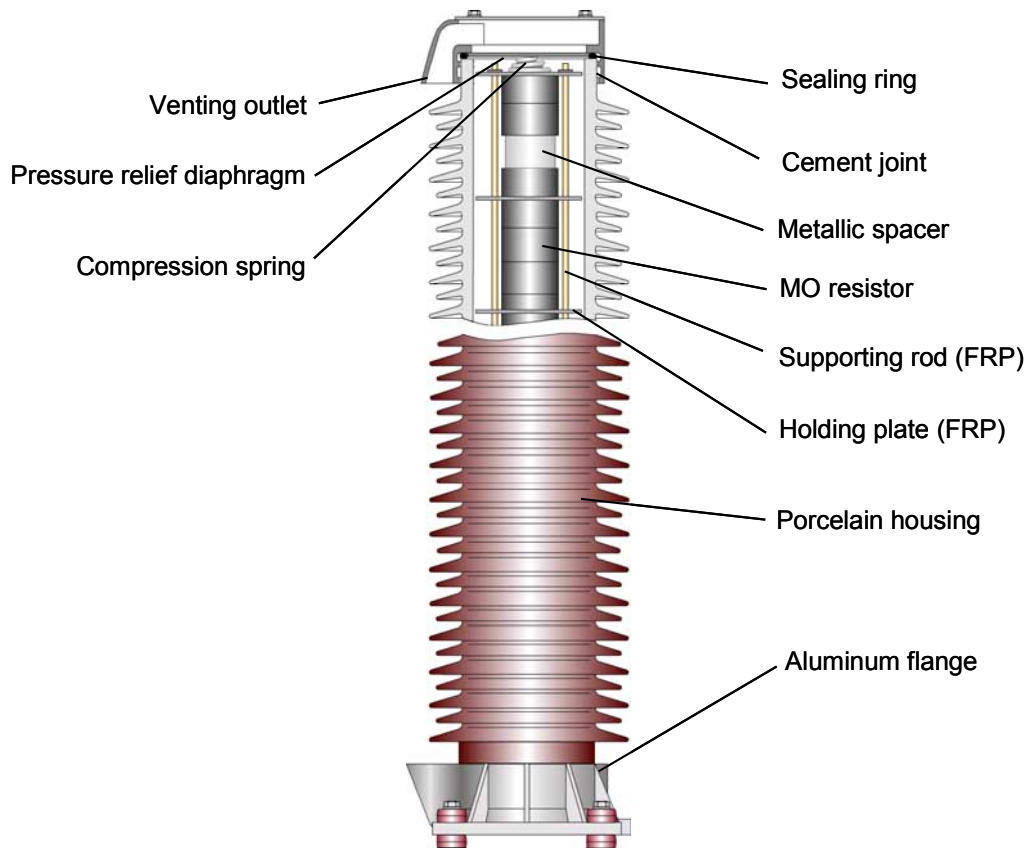

Fig. 8: Cross-sectional drawing of the unit of a porcelain housed MO arrester

are also realized in a multi-column technique, that is, two or more columns are connected in parallel.

MO resistors vary in height between ca. 20 mm and 45 mm. For the most part, the height is associated with the production and depends on the available tools and manufacturing facilities. However, not every height can be manufactured, since the greater the height (as well as the diameter), the harder it is to achieve sufficient homogeneity of the resistor material during manufacturing. This, however, decides most of all upon the energy absorption capability and even more upon the reproducibility of specified technical data.

The residual voltage per millimeter of height during a lightning current impulse of 10 kA peak value – the so-called 10 kA residual voltage – is within a range of about 450 V/mm for a typical MO resistor in a distribution arrester (32 mm diameter) down to



Fig. 9: Metal-oxide resistors

about 280 V/mm for an arrester used in a 420-kV-system (70 mm diameter)¹. In the last case mentioned, the 45 mm high resistor, therefore, has a 10 kA residual voltage of about 12.5 kV. In order to achieve a lightning impulse protective level of 823 kV, as in the example in Figure 2, about 66 resistors would have to be stacked on top of each other. Since the resulting height of the MO resistor column of almost three meters could not be contained in a single housing, this arrester would consist of at least two units in series.

The length of the active part is fitted to the housing length of the unit by means of **metallic spacers**. In the simplest cases these are aluminum tubes with end covers in order to achieve an evenly distributed contact pressure. Sometimes, however, massive aluminum parts are inserted, which at the same time serve as heat sinks, thereby increasing the thermal energy absorption capability of the arresters.

The MO resistors stacked on top of each other in this way have to be mechanically fixed in the housing. The aim is, on the one hand, to ensure that the active part cannot be moved out of its original position during transportation, or when the arrester is installed in a position which is other than vertical. On the other hand, a certain axial contact pressure is necessary, so that the occurring current stresses can be easily handled. Figure 8 depicts one of the many achievable possibilities. Several **supporting rods** out of **FRP (fiber-glass reinforced plastic)** material encircle the MO resistor column like a cage. **Holding plates** – also out of FRP – additionally provided at regular intervals, on the one hand, prevent the supporting rods from being bent apart, and on the

¹ The main reason for these differences are the different current densities, depending on which diameters are used, based on a current value of 10 kA. The lower the current density, the lower the residual voltage is.

other hand, limit possible sagging of the whole construction towards the housing walls. A strong **compression spring** (for higher requirements, possibly more than one) which is attached to the upper end of the column, braces the active part in the housing.

High demands are made on the electrical and mechanical properties of the whole supporting construction. It must be designed and implemented in such a way that it remains free of electric partial discharges under all operating conditions. In addition to high mechanical strength, high temperature resistance and high tracking and erosion resistance, as well as flame retardant and self-extinguishing properties in case of fire are required.

Up until recently, and for high-voltage, still today in most cases – as shown in Figure 8 – only **porcelain** was used for the arrester housing¹. The ends of the housing are equipped with **aluminum flanges**² which are applied with the help of **cement**³. When choosing aluminum material of a quality for outdoor use, external paint is not necessary for the flanges.

[Sulfur cement](#) is the first choice for cementing. Besides favorable mechanical properties, it also proves to have advantages over [Portland cement](#), which is quite common in the insulator industry, in the manufacturing process: it can easily be brought into contact with aluminum without causing corrosion, and it can be quickly processed, since directly after application it already almost reaches its mechanical final strength.

Assuming the flanges and the end sections of the porcelain housing are appropriately designed, it is possible to achieve a cement joint that is always mechanically stronger than the porcelain itself. That means that the strength of the porcelain can fully be made use of, when specifying the permissible mechanical head loads of the arrester housing.

Insulator porcelain is manufactured in different qualities, for which the minimum requirements are found in standards, e.g., IEC 60672-3. For arrester housings normally two qualities are used: the [quartz porcelain](#) (subgroup "C 110: siliceous porcelains" according to IEC 60672-3) and the [alumina porcelain](#) (subgroup "C 120: aluminous porcelains"). Higher mechanical strength can be achieved with alumina porcelain which, in

¹ Explanatory examples for polymer housed arresters will be given later in this chapter. More detailed information on this will be included in part 2 of the handbook.

² Sometimes when mechanical requirements are particularly high, steel flanges are also used.

³ Designs with clamped-on flanges are also common.

comparison to the quartz porcelain, has about double the amount of specific strength. One important influence on the mechanical strength is the glaze, which is applied not only to the outside, but also to the inside of the porcelain walls. The strength of the housing naturally depends greatly on the geometry of the porcelain as well. Not only the wall thickness, but also the diameter play an important role here. The higher the system voltage, and as a result the greater the requirements on mechanical strength, the greater the diameter of the porcelain that will be chosen¹.

The color of the glaze, however, has no technical significance. The most common color is brown (color RAL 8016). Frequently, however, especially in the Anglo-American regions, a light gray tone is preferred. A certain influence of the color on the inner-arrester temperature, because of different thermal emittance and absorption coefficients, can be theoretically derived. Its total effect, however, remains negligible, such that for practical purposes, it is not taken into consideration.

Besides protecting the active part from environmental influences, the arrester housing above should also provide an adequate creepage distance. For this reason it is equipped with sheds whose designs can differ greatly. For the design of the shed profile (distances, overhang, angle of inclination) the application guide IEC 60815 makes recommendations which should be followed by the manufacturer. The most noticeable is the difference between an alternating and a normal shed profile (Figure 10). No general recommendation can be made about which of the two types is more preferable. The

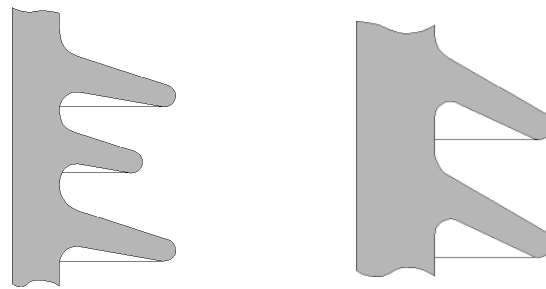

Fig. 10: Alternating shed profile (left) and normal shed profile (right)

¹ A bigger porcelain diameter can also be appropriate for reasons of short-circuit withstand capability and of the operational performance under polluted conditions. The latter might not directly be obvious, but will be explained in more detail in part 2. In brief: bigger diameters cause, on the one hand, stronger electric discharge activities on the surface which, on the other hand, have less thermal impact on the arrester's active part due to the large distance and consequently small coupling capacitances between the outer surface and the MO resistors. Also internal radial electric field stress and thus the risk of inner partial discharges is much lower for bigger housing diameters.

advantages of the alternating shed profile include the prevention of continuous conductive layers from appearing on the surface, and that a large ratio of the creepage distance to the total length can be achieved, which at any creepage distance requirements leads to shorter arrester housings. In artificial pollution tests in salt fog (in accordance with the standard IEC 60507), it generally performs better than the comparable normal shed profile. The latter, on the other hand, proves to have particularly good self-cleaning properties under real service conditions, and as a result, in many cases it has an excellent service record. In case of doubt when choosing a shed profile, the user's individual operational experience should be considered.

The commentary to Figure 8 concludes with a description of the sealing system. This is one of the most critical components of the arrester; the type of failure in arresters most frequently mentioned in arrester literature and by users is leakage. The sealing system has three tasks to fulfill, which are quite incompatible with each other. On the one hand, it must deter the ingress of moisture for the duration of the lifetime of the arrester – the duration is meant to be 25 to 30 years. On the other hand, it should act as a fast operating pressure relief device in the rare event of an arrester overload, which can cause a rapid build-up of pressure in the housing, and would otherwise lead to a violent shattering of the porcelain body. Finally, at this point, a well-defined current transfer from the flange to the MO resistor column must be established.

The example shown in Figure 11 consists of a sealing system, which for the most part is made up of a **sealing ring** and a **pressure relief diaphragm**. Both elements appear twice, that is at each end of the housing. The sealing ring is attached to the end face of the porcelain body. If the sealing occurs at this point then the cement between the flange and the porcelain is not part of the sealing system. This reduces the requirements on the cement bonding, but requires absolute care when working the porcelain end faces and during the subsequent quality control.

Great demands are made most of all on the material of the sealing ring. Thus, for example, natural rubber proved to be unsuitable, since with time it becomes brittle. Resistance to ozone is another elementary requirement, which nowadays can be fulfilled with the use of synthetic materials.

The pressure relief diaphragm, which is used in this arrester construction, consists of very pure high grade steel or nickel material, which is only a few tenths of a millimeter thick. In terms of the design and the quality assurance, it is challenging to make the diaphragm resistant to corrosion for a period of 30 years. The diaphragm is pressed against the sealing ring with a metal **clamping ring** screwed to the flanges. It is especially im-

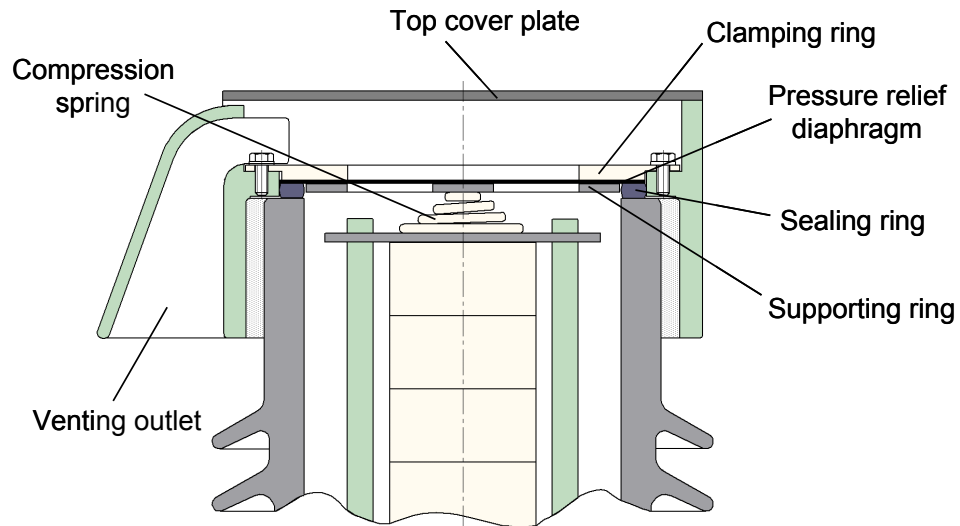

Fig. 11: Sealing system of a high-voltage porcelain housed MO arrester

portant to make certain that only compatible (with respect to electro-chemical processes) material combinations are used. Otherwise gap corrosion will definitely result, which sooner or later will lead to leakages.

The particular advantage of the pressure relief diaphragm¹ is its extremely short opening time in the case of an arrester overload. An arrester overload is a very infrequent occurrence². It cannot, however, in principle be ruled out, not even in the case of an overdimensioned arrester. Possible causes for this are, for example, direct lightning strokes occurring near the arrester, or power-frequency voltage transfer from a higher to a lower voltage system, for example, on a transmission line with several voltage levels which cross each other because of a conductor failure or galloping. In such a case an overload of one or several of the MO resistors occurs in the affected arrester. A partial arc builds up, which in split seconds turns into a complete arc between the two flanges inside the housing. The full short-circuit current of the net, which appears where the arrester is actually installed, flows through this arc. As a result, an abrupt increase in pressure develops within the housing. At the same time, the pressure relief diaphragm tears open within a few milliseconds, thereby ensuring a safe pressure relief before the bursting pressure of the housing is reached. The hot pressurized gases very rapidly escape from the inside of the housing through the two **venting outlets** ("venting" of the

¹ Other types of pressure relief devices are also common, for example, spring loaded covers.

² In high-voltage systems this occurs considerably less than in a distribution system. See part 2.

arrester). Outside the housing the two gas streams meet and cause the arc that was burning inside the housing, to commute and continue burning outside the arrester, until the failure has been cleared. Up to that point, breaking of the porcelain¹ can still occur as a result of the extreme thermal stress. However, because of the practically unpressurized decay, no other serious damage can ensue.

When the arc burning inside the housing is quenched as a result of a system fault clearing, which already occurs before the opening of the pressure relief diaphragm, or when the pressure build-up occurs relatively slowly, because of a very low fault current (which occurs especially in resonant earthed neutral systems), the pressure relief diaphragm does not rip, but instead only pulls wrinkles, which (in this case, intentionally) leads to leakage². This makes it impossible for a failed arrester to be under internal pressure of more than one bar and greatly reduces the security risks when dismantling a defective arrester.

The most important components of an MO arrester have been described above, employing a high-voltage arrester with porcelain housing as an example. However, a few other details are necessary to complete the description of a high-voltage arrester (Figure 12).

It has already been mentioned that starting at a certain length of the MO resistor column, an arrester is no longer manufactured in one piece. The longest a porcelain housing can reasonably be, is, for technical and economical reasons³, about two meters. At this length an arrester can be accommodated in one single unit for a solidly earthed neutral 245-kV-system, as long as creepage distance requirements are not higher than average. At all higher voltage levels, the arrester must consist of several units, for example in a 420-kV-system it would have at least two parts. At the higher voltage levels or when there are extreme creepage distance requirements, it can also be made up of three, four or five parts. In principle, there is no upper limit, as long as the arrester still proves to have sufficient mechanical properties.

¹ A so-called thermal or secondary breaking, which is expressly permitted according to the arrester standards.

² Such a defective arrester is recognizable from the outside by the heavy layer of black carbon on its housing.

³ One of the reasons is that the longer the housing, the lower the short-circuit withstand capability becomes. Another is that most porcelain insulator manufacturers cannot fire the greater lengths in one piece.

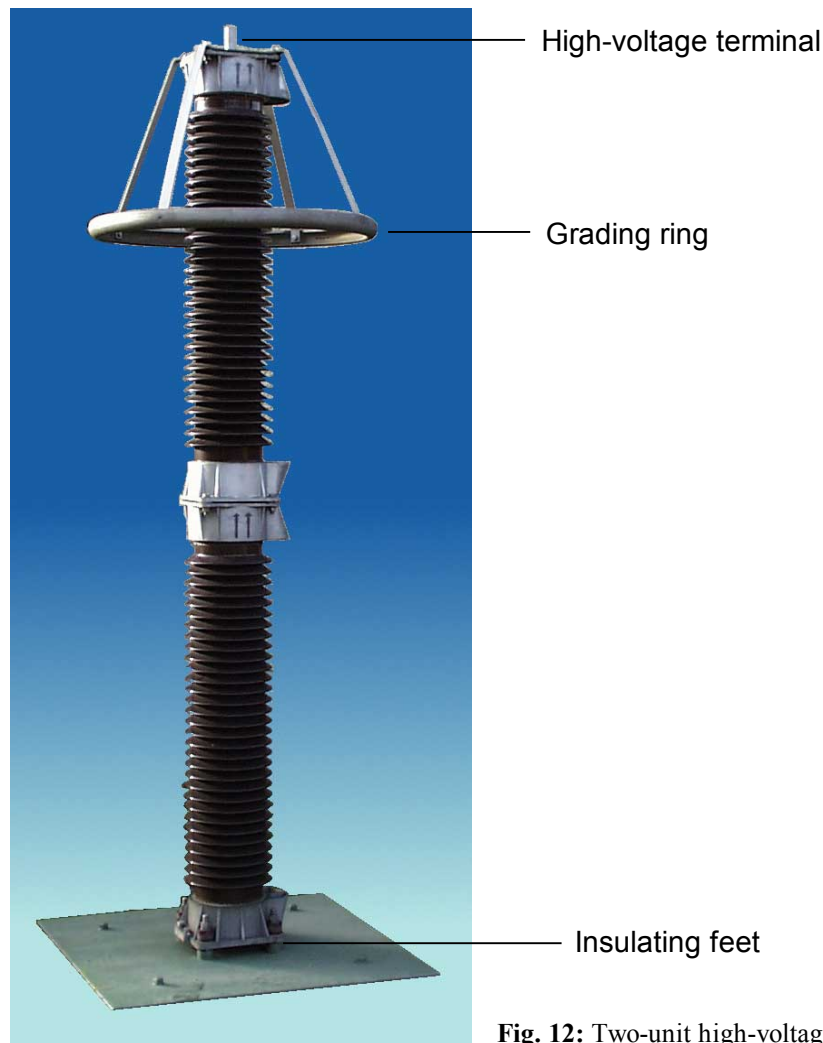

Fig. 12: Two-unit high-voltage arrester

Starting at a length of about one and a half to two meters on up, and generally for arresters made up of several units, **grading rings** are absolutely essential. These serve to control the voltage distribution from the top to the bottom, which is unfavorably influenced by the earth capacitances affecting the arrester. Without the appropriate countermeasures the MO resistors at the upper, high-voltage end of the arrester, would be stressed considerably more than those at the earthed end. The background and the exact interdependencies will be covered in greater detail in the second part of this handbook. Grading rings differentiate from each other in terms of their diameters and in the lengths of their fixing braces. The rule of thumb in this case is as follows: the larger the diameter and the longer the brace, the better the control effect is on the voltage distribution. At the same time there are two reasons for keeping both of the sizes mentioned small, if at all possible:

- The relevant standards on erecting electrical power installations¹ stipulate a minimum distance between the conductors of the neighboring phases. These requirements are also valid for the distance between the grading rings of two neighboring arresters. The smaller the grading ring, the smaller the centerline spacing of neighboring arresters can be, and thus the bay width to be selected.
- The braces cannot be lengthened to whatever size desired, since the empty arrester housing must fulfill certain withstand voltage requirements. If the braces are too long, flashovers may occur from the grading ring over the neighboring flange to the earth, or directly to the earth, especially while testing with [switching impulse voltage](#).



Fig. 13: Bottom flange with insulating feet and monitoring spark gap

High-voltage station arresters are usually not directly earthed; instead monitoring devices, such as [surge counters](#), [monitoring spark gaps](#) or [leakage current indicators](#) are connected with the arrester in series. In this case insulation is provided for by setting the arrester up on **insulating feet** (Figure 13). Earthing then occurs through the appropriate monitoring devices. The insulating feet must be mechanically designed in such a way, that they can withstand long-term as well as short-term mechanical forces affecting the arrester. They must have adequate electrical strength, so that they do not flashover under the stress of the voltage drops across the monitoring devices situated in parallel and caused by the self-inductance of the ground connection.

¹ For example, the European harmonization document HD 637 S1, or document IEC 99/35/CD, 1998 (Project IEC 61936-1 Ed. 1.0: Power installations exceeding 1 kV a.c. – Part 1: Common rules).

The ground connection lead should have a cross section of at least 35 mm², less for electrical reasons – for this a smaller value would be entirely adequate – than for reasons of mechanical strength and resistance against environmental impact.

The **high-voltage terminal** serves as the connection to the overhead line conductor. Normally bolts and flat terminals are used (Figure 14). Their design and dimensions are standardized, for example in accordance with [DIN](#) or – in the United States – with [NEMA](#). However special customer-specific variants are also common.



Fig. 14: Bolt terminal (left) and flat terminal (right)

The following pictures (Figures 15...17) show other models of MO arresters: a medium-voltage distribution arrester with porcelain housing, a medium-voltage distribution arrester with polymer housing and finally, a high-voltage station arrester with polymer housing. The chosen examples differentiate from each other, in some cases greatly, in their design features, and thus provide an overview of some of the basic arrester designs in use.

In distribution arresters with porcelain housing, of which millions are in use, but which nowadays are increasingly being replaced by arresters with polymer housing, almost all the components so far mentioned can be found (Figure 15). Even though low production costs are far more essential for such an arrester than for a high-voltage arrester, here too, especially for the sealing system, the highest possible standards must be maintained. Leakage turns out to be the most frequent cause of failure, especially for arresters in the medium-voltage range, where the cost pressure is enormous and the

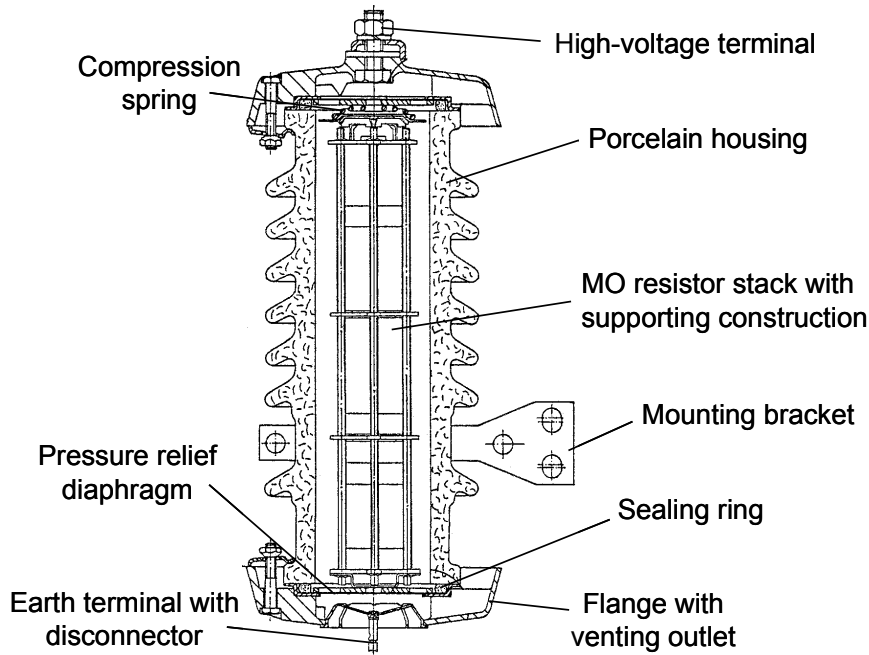

Fig. 15: Cross-sectional drawing of a porcelain housed MO distribution arrester

quality is not always the main concern¹. The arrester shown in Figure 15 generally has the same sealing system as the high-voltage arrester of Figure 8. The same principles and the same materials are used. This means that this design has the same high operational reliability as a high-voltage arrester. Also, that which was mentioned earlier in connection with high-voltage arresters, applies here to the overload performance, since the same pressure relief principle is relevant here as well².

A peculiarity of distribution arresters is their frequent application in connection with [disconnectors](#). This additional device can be not only integrated in the arrester, as depicted in Figure 15, but also be attached to its outside. Disconnectors may be of great importance for a trouble-free operation of a distribution network. Here the locations of the arresters are not limited to only a few switchyards or substations, as in a high-voltage transmission system. Instead arresters are distributed throughout the whole net (pole stations, cable terminations), and in many cases an arrester which has broken down is not noticeable within this great spatial expanse. And even if it is, replacements cannot

¹ However, the failure rate of distribution arresters, not counting sealing problems, is still higher than that of high-voltage arresters, because they are more frequently overloaded by nearby direct lightning strokes.

² There were, and still are, many designs of distribution arresters with porcelain housing not provided with a pressure relief device at all.

always immediately be made. The disconnecter is supposed to ensure that, after a possible failure, the arrester is separated from the network. Otherwise the arrester could, after such an incident, form a permanent earth fault. It should, however, also be mentioned that the disadvantage of a disconnecter is that as a result of using it, arrester failures may remain unnoticed, and overvoltage protection at this point might unintentionally not be attained. Therefore, for the use of disconnecters no general recommendations can be given. They are used less frequently or sometimes not at all in resonant earthed neutral systems, which can be operated over longer periods of time under earth fault conditions. They are, however, used more frequently in solidly earthed neutral systems. Individual cases depend greatly upon the system management of the different utilities.

In the example shown in Figure 15 the disconnecter is a pot which is pressed into the bottom flange in an appropriate form. The hot gases which appear when the arrester is blowing out, expel the pot together with its connected earth wire, and so bring about a separation from the line.

A totally different method of construction of a distribution arrester is shown in Figure 16. Finally, because of the failures caused by leakage in cheaply designed distribution arresters with porcelain housing, the first ones equipped with polymeric outer insulation appeared on the market in the late 1980's. Their most remarkable design feature is the polymer housing located directly on the MO resistor stack. As a result, the gas-filled gap between the MO resistors and the housing no longer exists, and with the appropriate constructive realization of the interface between the polymer housing and the end fittings, a sealing system can be completely omitted. Similarly, in case of an overload, a pressure buildup and the related risk of housing breakage can be avoided. In part 2 it will be shown in greater detail that a number of different designs are possible based on this principle¹.

In the case of a porcelain insulator, different properties – such as, protection from environmental impact and provision of sufficient creepage distance on the one hand, and mechanical strength on the other – are united in a single component. In an arrester with polymer housing, however, these properties are apportioned to two different com-

¹ In that part, it will also be discussed that the arresters built according to this principle are not "per se" moisture tight and break resistant in case of overloading, as was anticipated in the beginning. With these arresters specific design characteristics and the quality of manufacturing also continue to play an important role.

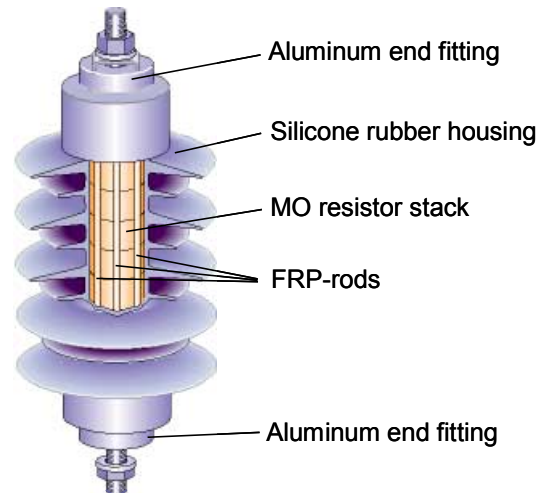

Fig. 16: Construction of a polymer housed MO distribution arrester

ponents. Mechanical strength is almost always achieved with fiber-glass reinforced plastic (FRP) materials. In the example shown in Figure 16, several rods serve this purpose. They are strained in the end fittings and enclose the MO resistor stack¹. This is how a mechanical high-strength unit out of MO resistors, end fittings and the FRP structure are created. This module is inserted in a mold, in which [silicone rubber](#) is directly injected. With the appropriate manufacturing techniques, it is possible to obtain a perfect bond of the silicone rubber with the other components, void-free and permanent. One advantage of the applied silicone rubber in this case, in comparison to cheaper materials, which are also used, is the excellent endurance properties – by now, it is possible to fall back on about 30 years of service experience in this area. Another advantage is a characteristic unique to silicone rubber, [hydrophobicity](#): even if the silicone surface is heavily polluted, water simply drips off. This suppresses the formation of conductive layers and advantageously affects the operational performance of the arrester in polluted conditions.

The risk of the housing bursting and splitting in case of an arrester overload for the design shown in Figure 16, is nonexistent. The arc resulting from a puncture or a flash-over of the MO resistors rips the silicone rubber housing open, and with almost no resistance, finds its way outside.

¹ Another common version uses wrapped mats. After the resin within these mats is cured, it forms a stiff tube which directly bonds to the MO resistors.

The advantages of such an arrester design have only been hinted upon here. The combination of the given weight reduction in comparison to a porcelain housing, the non-risky handling during transportation and installation, and last but not least, the savings in cost that manufacturing such an arrester offers in comparison to an arrester with porcelain housing, present advantages which make it clear why the polymer housed arresters within the medium voltage range have become so popular. As a result, it is also apparent why the devices with porcelain housings have, in this case, virtually disappeared from the market.

For the high- and especially for the extra-high-voltage levels, the situation, at least for now, is different. With the design shown in Figure 16, there are electrical and mechanical demands which become ever more difficult to fulfill, the higher the voltage level. The design in Figure 17, which also was already introduced at the end of the eighties, proved, on the other hand, able to fulfill these requirements very well¹. One

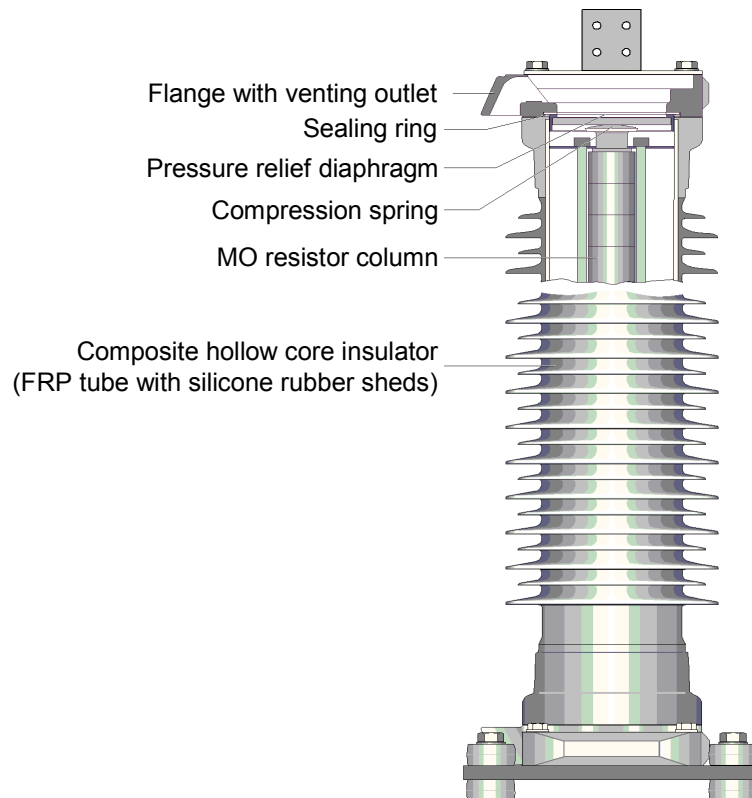

Fig. 17: Cross-sectional drawing of the unit of a polymer housed high-voltage arrester (with composite hollow core insulator housing)

¹ But nevertheless, the arrester designs with polymer housings directly bonded to the MO resistors are also applied in high- and extra-high-voltage systems.

notices immediately that, in principle, this has the same design as the one in Figure 8. Indeed, essentially only the porcelain insulator has been replaced with a [composite hollow core insulator](#), found also, for example, in instrument transformers and bushings.

A composite hollow core insulator is made up of an FRP tube on which the sheds – practically only ever made out of silicone rubber – are [directly molded](#) on, or [pushed on](#) and [vulcanized](#) in the form of individual prepared sheds. This design principle offers some considerable advantages for applications up to the highest voltage levels. Since the inner structure of an FRP tube (for example, relative content of glass fibers, or the winding angle of the fibers), its wall strength and its diameter can, within a large range, be selected without restrictions, such a tube can be endowed with almost any mechanical property. As a result, to name just a few, it can be optimized with respect to tensile strength, bending strength, or internal pressure strength. Thus, it is possible to design high-voltage arresters which are so mechanically strong, that they can endure the most severe earthquakes intact and at the same time be used as a post insulator in a substation.

The application last mentioned is of benefit to another property only found in this design: in the case of an arrester overload, it is certain that with this construction a housing breakage will never occur; not even any of the inner parts will be ejected. The tube will remain almost completely intact, and as a result it offers the best possible safety for the whole switchgear in a substation.

The higher costs of the composite hollow core insulator of such a design, in comparison to porcelain insulators, has been an obstacle to its being further distributed. As distribution of composite hollow core insulators increases, along with the corresponding market supply, a resulting acceptance of the technology is likely to make the use of this type of arrester in the area of high- and extra-high-voltages ever more popular.

Configuring MO Arresters

In order to configure an MO arrester, it is first of all necessary to understand how the different requirements and parameters affect the operational performance of the arrester. With knowledge of the basic principles and interdependencies, it is then possible to lay out an appropriate arrester for less common applications. This chapter describes the general approach and concludes with simple sample calculations to select typical arresters for overvoltage protection in a.c. distribution and transmission systems at voltage levels between $U_s = 24$ kV and $U_s = 550$ kV.

The description is given only in view of the device, in other words, so that the question of how an arrester should be configured is answered in a way that, on the one hand, it fulfills its protection requirements and on the other, does not become a problem itself. However, the application will not be discussed here, as to where in the system or on which equipment the arrester should be applied to. For this, the appropriate IEC publications 60071-1 and 60071-2 on insulation coordination or the selection and application recommendations for surge arresters, IEC 60099-5, can be consulted. Some special applications will be discussed in the second part of the handbook.

In this chapter the decisive international¹ standards for testing and application of metal-oxide surge arresters without gaps will, for the most part, be referred to: IEC 60099-4, IEC 60099-5, IEC 60099-1 as well as the document IEC 37/268/FDIS from July 13, 2001, which is currently being voted upon².

For the most part, the requirements for an MO arrester can be traced back to two basic requirements. On one hand arresters should provide adequate protection, and on the other they should be laid out for stable continuous operation. Adequate protection means that overvoltages at the device to be protected must always remain below its withstand voltage, with a sufficient safety margin. Stable continuous operation means that the arrester must be able to handle all long-term, temporary or transient stresses which result from network operation, while remaining electrically and thermally stable under all conditions.

Both basic requirements cannot be fulfilled independently. A reduction of the protective level automatically means a higher specific electrical stress during continuous

¹ Some of the relevant American national [IEEE](#) standards are listed at the end of this chapter.

² More information on these standards are included in the relevant chapters in part 2.

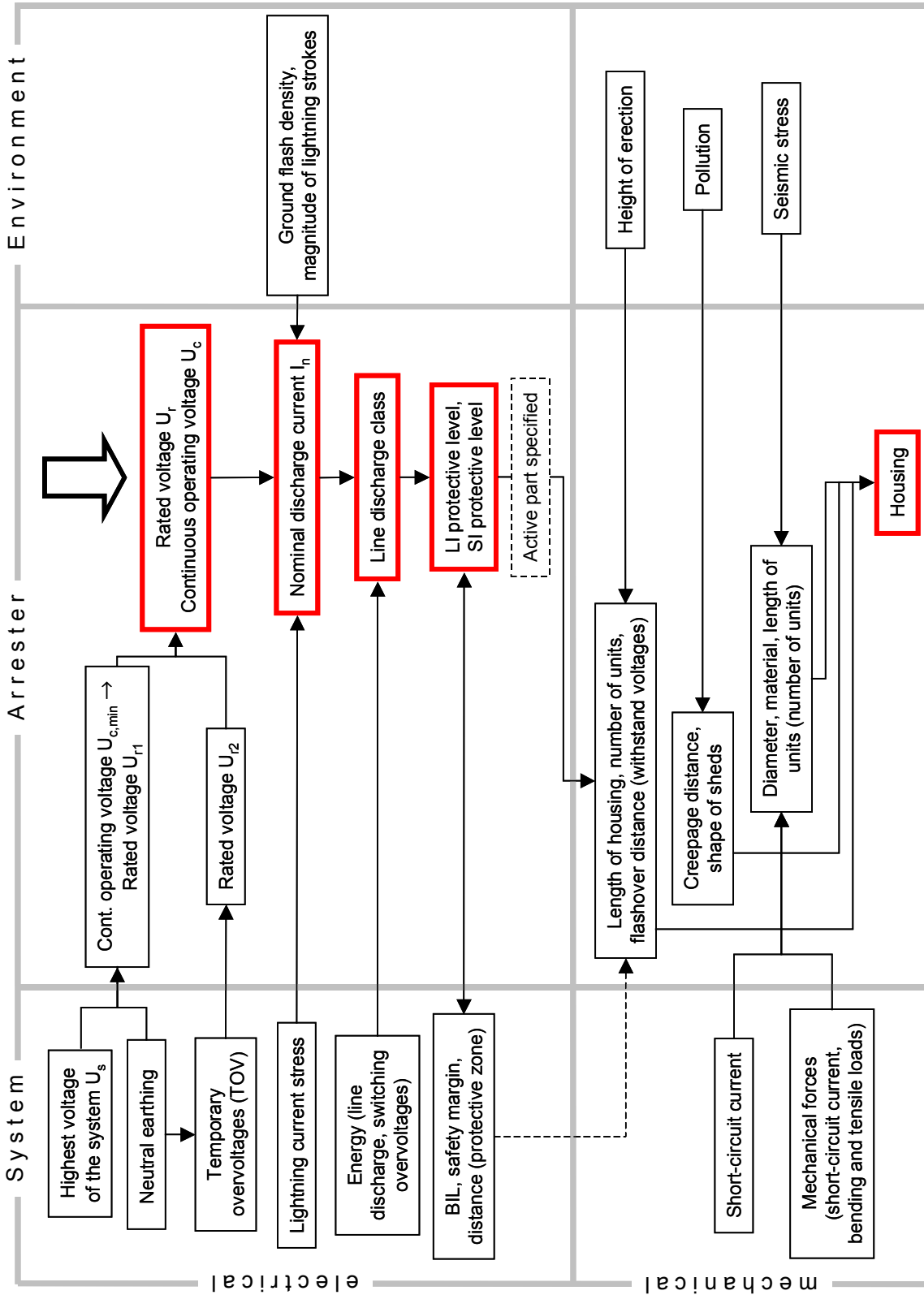

Fig. 18: Procedure for configuring an MO arrester

operation, and conversely, the continuous operating voltage of an arrester cannot be increased arbitrarily without raising its protective level as well. Both operating points are – at least for a given type of MO resistor – strictly associated with each other through the voltage-current characteristic curve.

Additional requirements involve the electrical characteristics of an arrester: they should not change during its life span, and insensitivity to environmental influences, such as pollution, solar radiation or mechanical strain, must be maintained.

In Figure 18 a flow chart illustrates an approach to configuring an arrester. In this case a high-voltage arrester is depicted, since, in comparison to a distribution arrester, more and higher demands are made here. The steps shown in the picture will be discussed below in more detail in the sequence in which they are carried out.

Choosing the Continuous Operating Voltage and the Rated Voltage

So that the arrester can protect safely, it must be able to work absolutely soundly in continuous operations. Thus, the first step is to establish a minimally required continuous operating voltage $U_{c, \min}$. As already mentioned in connection with Figure 2, this must be as high as the continuous phase-to-earth voltage of the system, provided with at least an additional 5%. The allowance takes into account possible harmonics in the system voltage, which may increase its peak value¹.

Here "continuously" applied voltage means every voltage which occurs within an uninterrupted period of more than 30 minutes. For this reason to determine the continuous operating voltage, the type of neutral earthing of the system is decisive. In isolated or resonant earthed neutral systems², the voltage of a healthy phase against ground takes on the value of the phase-to-phase voltage in the case of a one-phase earth fault ([earth fault factor k](#) = 1.73). Since resonant earthed neutral systems are operated quite commonly for time periods of more than 30 minutes in this condition, the continuous

¹ Because of the extreme non-linearity of the U-I-characteristic, the r.m.s. value of power-frequency voltage plays less of a role than its peak value, which can overproportionally increase the resistive component of the leakage current periodically at the moment of the voltage peak.

² Resonant earthed neutral systems are mainly found in central Europe, from the medium voltage range up to the 170-kV-level. Systems at higher voltage levels in general have solidly earthed neutrals.

operating voltage of the arrester must, in this case, have the value of the highest voltage of the system, U_s . Only the additional five percent is not taken into consideration here:

Solidly earthed neutral system:

$$U_{c, \min} \geq 1.05 \cdot U_s / \sqrt{3}$$

Isolated or resonant earthed neutral system:

$$U_{c, \min} \geq U_s$$

With the pre-selection of the minimally required continuous operating voltage, a factor which usually has a value of 1.25¹ – there are, of course, exceptions – helps in achieving a rated voltage $U_{r1} = 1.25 \cdot U_{c, \min}$. This is a possible, though not final, rated voltage of the arrester:

Solidly earthed neutral system:

$$U_{r1} \geq 1.25 \cdot 1.05 \cdot U_s / \sqrt{3}$$

Isolated or resonant earthed neutral system:

$$U_{r1} \geq 1.25 \cdot U_s$$

The required rated voltage can, however, also be reached by taking a completely different approach, namely by examining the temporary overvoltages which may occur in the system. The special case of a system, which is operated with a resonant earthed or isolated neutral, and in which the temporary overvoltages are directly decisive for the continuous operating voltage, has already been mentioned. On the other hand, in the case of solid neutral earthing, the temporary overvoltages may reach values of up to 1.4 times the maximum phase-to-earth voltage (earth-fault factor $k \leq 1.4$) for a time period from a few tenths of a second to up to several seconds. Power-frequency voltage above its continuous operating voltage can only be applied to an arrester for a limited period of time: the higher the voltage, the shorter the permissible time of application is. This correlation is depicted in the [power-frequency voltage versus time](#) or U-t-characteristic (Figure 19). This indicates the ratio of the permissible power-frequency voltage and the rated voltage U_r , both given as r.m.s. values, over time, represented in logarithmic standards. The ratio is called the factor k_{tov} . In this case it is assumed that the arrester is in an unfavorable state, that is, that the arrester has previously been heated up to 60 °C, and directly before the application of power-frequency voltage it had to absorb its full rated thermal energy. From Figure 19 it is clear that under these conditions the rated voltage U_r may be applied for a time period of 100 seconds². The ten-second-voltage is,

¹ There are no physical reasons for the value of 1.25; it was a purely empirical result, which occurred during the manufacturer-independent development of practically all types of MO arresters.

² In the [operating duty test](#) (during the type test) the rated voltage need only be applied for a duration of 10 seconds. The configuring at 100 seconds in this case provides additional security.

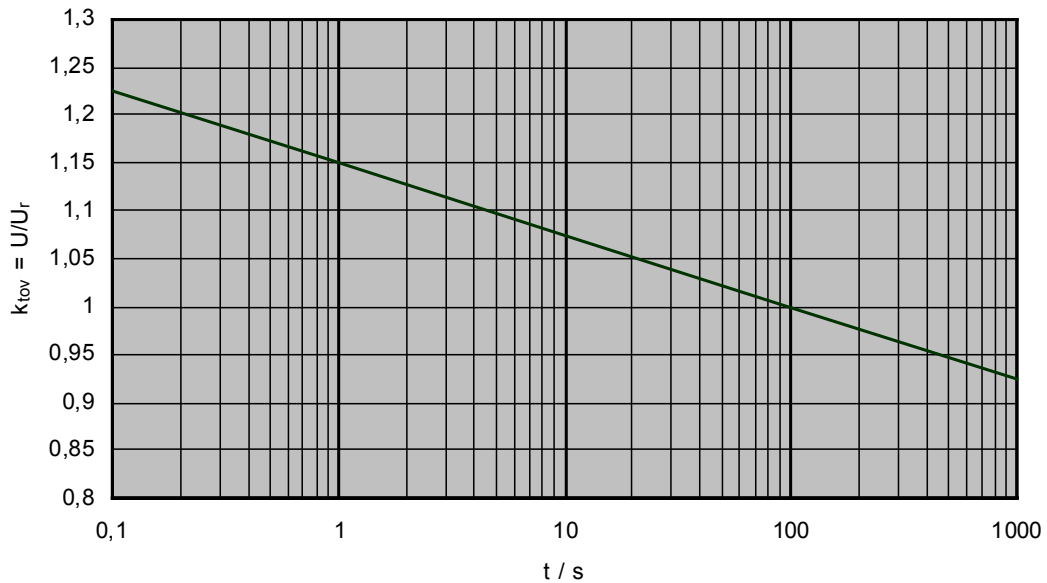

Fig. 19: Example of a power-frequency voltage versus time (U-t-) characteristic

on the other hand, 7.5 % above the rated voltage and the one-second-voltage already 15 % above. The U-t-characteristic is applied in the following manner: the voltage value U_{tov} , which occurs in a system for a time period of 1 s, would, for example, be known. This voltage value must correspond, according to the U-t-characteristic curve, to 1.15 times the arrester-rated-voltage ($k_{tov} = 1.15$). In other words, the possibly chosen rated voltage of the arrester, U_{r2} , is the occurring 1-s-voltage value divided by a factor k_{tov} , which is valid for a time period of 1s, in this case, therefore, $U_{r2} = U_{1s} / 1.15$. In general this reads as:

Solidly earthed neutral system:

$$U_{r2} = U_{tov} / k_{tov}$$

If further sets of temporary overvoltage values and the time of their occurrences are available as a result of knowing the systems conditions, then for each one the corresponding rated voltages must be determined separately. If no information is available at all, then in the case of a solidly earthed neutral, an earth-fault factor of 1.4, and a time period of ten seconds should be assumed for the occurrence of temporary overvoltages. The highest value of the different rated voltages determined from the temporary overvoltage conditions as described above, is the rated voltage U_{r2} in Figure 18. Only a small step is now needed to determine the final rated voltage of the arrester – U_r is the

higher of the two values U_{r1} and U_{r2} , rounded up to the next highest value divisible by three¹:

$$U_r = \max \{U_{r1}, U_{r2}\}$$

rounded up to a value divisible by three

If the rated voltage U_{r2} is greater than U_{r1} , then the continuous operating voltage must obviously be redefined:

$$U_c = U_r / 1.25$$

After determining the continuous operating voltage and the rated voltage in this way, the arrester is then generally designed not only for a stable normal continuous operation, but also for all temporary overvoltage conditions in the system. It is, however, recommended that a somewhat higher rating than the described minimal rating is selected, as long as the protective level of the arrester does not, as a result, become unjustifiably high. In most cases the protective level requirements allow for this². A higher rating increases the stability of the arrester and provides additional safety, for example in a heavily polluted environment, or when unexpectedly higher temporary overvoltages occur. For this reason one normally finds arresters in the systems which have continuous operating and rated voltages higher than the minimally required ones. However in each case this greatly depends on the utility's individual system management.

Selecting the Nominal Discharge Current

The nominal discharge current serves to classify an MO arrester. IEC 60099-4 specifies five different values³, which belong to different ranges of rated voltage:

¹ The standard IEC 60099-4 refers to steps in which the rated voltages are to be stated. These are between 1 kV and 24 kV, depending on how high the rated voltage is. At the same time other steps are permitted, as long as it results in a rated voltage which is divisible by 6. Currently even finer steps, e.g. 3 kV, are also offered for the highest rated voltages.

² An exception is found in the systems at the highest voltage level, $U_s \geq 550$ kV. Demands for lower switching impulse protective levels normally limit the amount that the rated voltage can be raised above the minimally required value. Also see the examples at the end of this chapter.

³ From IEC 60099-4, Table 1. The IEC standard in general lists nominal discharge current values in amperes. However, because it is easier to work with kiloamperes, details are now given in this form.

1 500 A	2 500 A	5 000 A	10 000 A	20 000 A
under consideration	$U_r \leq 36 \text{ kV}$	$U_r \leq 132 \text{ kV}$	$3 \text{ kV} \leq U_r \leq 360 \text{ kV}$	$360 \text{ kV} < U_r \leq 756 \text{ kV}$

These values, however, do not directly reveal anything about the operating characteristics. Thus, for example, a 10-kA-arrester can readily withstand lightning current impulses of higher amplitudes without sustaining damage. The actual function of these classifications is to specify different further demands and test requirements, depending on their class.

For distribution arresters, which are mainly used with classes 5 kA and 10 kA, the nominal discharge current represents a real differentiating characteristic. When carrying out an [operating duty test](#), the energy into a 5-kA-arrester is injected in the form of two [high current impulses](#) of 65 kA each, after it has previously been [conditioned](#) with 20 lightning current impulses of 5 kA (which is its nominal discharge current). With the 10-kA-arrester, on the other hand, the appropriate value of the high current impulses is 100 kA, and the value of the lightning current impulses is 10 kA. Since this means a considerable energetic stress for the small MO resistors (with diameters in the range of less than 30 mm to up to 45 mm), as are used for distribution arresters, a 10-kA-arrester must indeed be equipped with larger volume MO resistors than those needed for a 5 kA type, in order to pass this test. For central European distribution systems, 5-kA-arresters are completely adequate. Only in exceptional cases (e.g., because of an above average [keramic level](#)) is the use of 10-kA-arresters recommended. In practice the 10-kA-arrester is becoming ever more common, as the price difference between the two types diminishes, while at the same time there are logistic advantages to using only one arrester type for the entire system.

For high-voltage arresters only two classes, 10 kA and 20 kA, are appropriate. According to the table above, the use of a 5-kA-arrester would also be feasible in a 170-kV-system; however, in practice, it is uncommon. Also, the application guide IEC 60099-5 recommends the 5-kA-arrester for voltages of only up to $U_s = 72.5 \text{ kV}$.

A main difference between the two classes, 10 kA and 20 kA, is the [line discharge class](#) which they can be assigned to: for a 10-kA-arrester, it is classes one to three, for a 20-kA-arrester, classes four and five. Accordingly, different 10-kA-arresters can have very different operating characteristics, and the actual classifying characteristic is not so much the nominal discharge current, as the line discharge class. 10-kA-arresters of line discharge class 3 can generally be used in systems with levels of up to and including 420 kV without any problems. However, 20-kA-arresters are also utilized at this voltage

level, sometimes while using the same MO resistors. It is, however, for the most part not technically necessary.

Selecting the Line Discharge Class

The line discharge class is the actual determining characteristic of a high-voltage arrester. Presently it is the only way of specifying the energy absorption capability of an arrester in accordance with IEC 60099-4. It is, however, only indirectly found within the value of the line discharge class. The relationship is relatively difficult to understand. This has, in the end, prompted almost all the manufacturers to include more details on the energy absorption capability in their catalogues, than those provided in IEC standards¹.

The definition of the line discharge class is based on the assumption that a long transmission line, charged to a certain overvoltage during a switching operation, will discharge into a connected arrester in the form of a [traveling wave process](#). Assuming the equivalent circuit diagram of a line is an iterative network of [\$\pi\$ -elements](#), formed by inductances and capacitances, the current will flow at a value which is determined by the voltage value and the surge impedance of the line, for a duration given by the length of the line and the propagation speed of an electro-magnetic wave. Ideally, it adjusts to a rectangular-shaped current impulse. This process must be simulated in a laboratory in a [line discharge test](#). In this case the current impulse is normally generated with the help of a [distributed constant impulse generator](#), which is nothing more than the line simulation made up of a series connection of a finite number – about 20 to 30 – of π -elements. The IEC standard 60099-4 now defines five different line discharge classes. Increasing demands are made on the arrester from class one to class five, in which the electrical parameters of the impulse generator are established for the test:

¹ The line discharge class system actually was first used for gapped arresters with current-limiting series gaps. At the beginning of the 1980's – when MO arrester technology was still in its infancy – a testing standard for MO arresters was developed, and the existing system was adopted, since there were no better alternatives. After such a system is introduced, it is difficult to change it again. In some cases new definitions for energy absorption capability are, however, being considered. These are more appropriate for stresses associated with today's arrester applications (see the chapter on energy absorption capability in part 2).

Line discharge class	Surge impedance of the line Z in Ω	Virtual duration of peak T in μs	Charging voltage U_L in kV (d.c.)
1	$4.9 \cdot U_r$	2000	$3.2 \cdot U_r$
2	$2.4 \cdot U_r$	2000	$3.2 \cdot U_r$
3	$1.3 \cdot U_r$	2400	$2.8 \cdot U_r$
4	$0.8 \cdot U_r$	2800	$2.6 \cdot U_r$
5	$0.5 \cdot U_r$	3200	$2.4 \cdot U_r$

U_r = rated voltage of the test sample as an r.m.s. value in kV

These parameters are derived from typical characteristic values of high-voltage transmission lines¹. No direct conclusions about the energy stress which is imposed on the arrester during a test can be drawn from this table. For that reason the IEC standard 60099-4 provides an additional diagram which represents the converted energy in a test object, with reference to its rated voltage², which occurs during a single line discharge³. This energy is not a fixed value, but instead depends on the arrester protective level, or more precisely, on the switching impulse residual voltage. The higher the residual voltage, the less energy the arrester absorbs during the line discharge, since the line will discharge less intensely when the residual voltage is higher. The diagram referred to is depicted in Figure 20. It is now possible to easily identify the problem when the energy absorption capability is specified with the help of the line discharge class. If MO resistors are applied with a given amount of specific energy absorption capability, then the arrester can, depending on the residual voltage it has, be assigned to different line discharge classes. The following example proves this (the dashed lines in Figure 20): when using MO resistors, which can absorb 2 kJ/kV of energy per line discharge (i.e., double the value, namely 4 kJ/kV, during the operating duty test – performed with two successive line discharges – without becoming thermally unstable), the arrester has a line discharge class of two at a ratio of $U_{\text{res}}/U_r = 2$. However, with the same MO resistors it

¹ Also see IEC 60099-1, Table C.1 or IEC 60099-5, Table 1, as well as the chapter on energy absorption capability in part 2.

² It is common – in the standard IEC 60099-4 as well – to use the rated voltage when referring to specific energy. Some manufacturers, however, use the continuous operating voltage as the reference value, due to, among other things, the fact that the rated voltage is not defined in the US arrester standard, IEEE C62.11 (instead, a "duty cycle voltage rating" is specified there, whose definition is different from that of the rated voltage in the IEC standard).

³ During the [switching surge operating duty test](#), which has to be performed on arresters of line discharge classes 2 to 5, the test object is subjected to **two** of these discharges within an interval of about one minute. That means an arrester can absorb at least twice the amount indicated in the diagram, without becoming thermally unstable.

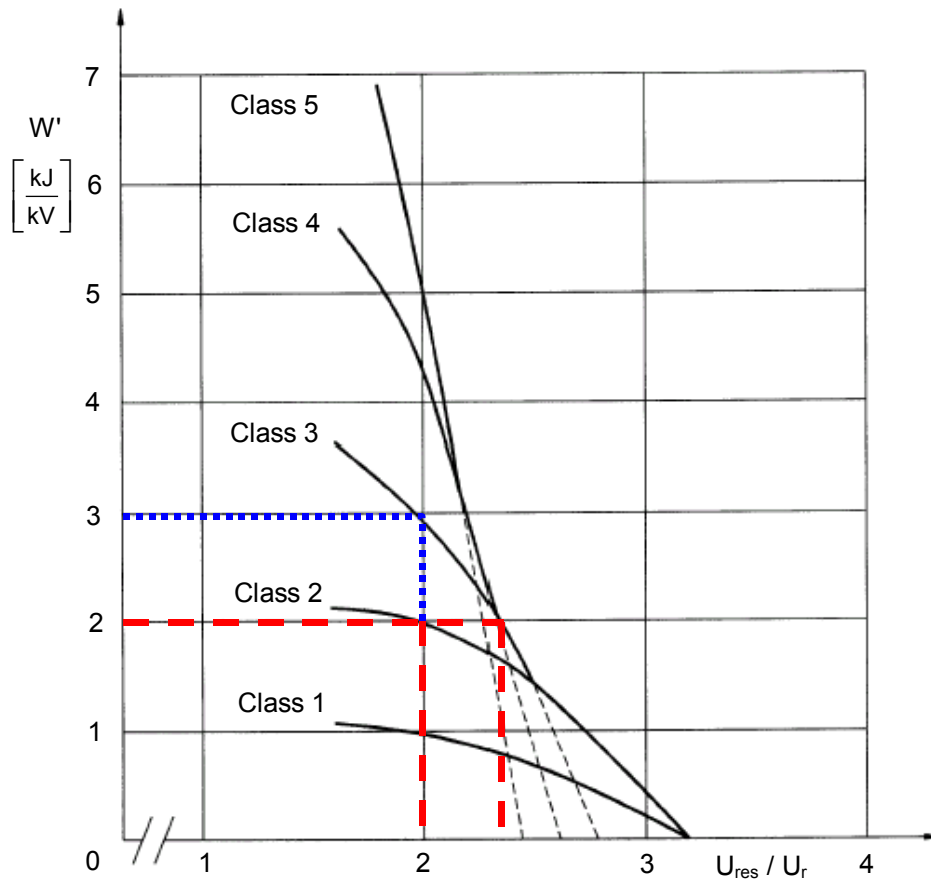

Fig. 20: Specific energy in kJ/kV of rated voltage dependent on the ratio of switching impulse residual voltage U_{res} to the r.m.s. value of the rated voltage U_r of the arrester (from IEC 60099-4)

already can be assigned to line discharge class three at the ratio of $U_{\text{res}}/U_r = 2.35$. But the seemingly "better" arrester with the line discharge class of three might possibly be worse for the planned application, since its protective level is higher! In order to reach the line discharge class of three while maintaining a ratio of $U_{\text{res}}/U_r = 2$, MO resistors must be used with an energy absorption capability of almost 6 kJ/kV (about 3 kJ/kV per discharge: the dotted lines in Figure 20), that means those with greater diameters.

Inversely, one can only draw conclusions from the line discharge class in connection with the residual voltage as to the energy absorption capability of an arrester, and thus about the used MO resistors. It is important to make these interdependencies clear when selecting an arrester.

As long as there are no particularly easy or difficult requirements originating from the system, the following line discharge classes, depending on the system voltage, are recommended¹:

Line discharge class	U_s (kV)
1	≤ 245
2	≤ 300
3	≤ 420
4	≤ 550
5	≤ 800

In practice, however, one tends to select the next higher line discharge class, respectively, in the table. That leads to the problem of current line discharge class five frequently not meeting the demands of the extra-high-voltage systems with $U_s > 550$ kV. In fact, at this voltage level, and sometimes even at the 550-kV-level itself, MO resistor diameters and/or parallel connections of resistors are used, which yield much greater energy absorption capability than is necessary for line discharge class 5. For these systems it is, however, common to determine the requirements on the energy absorption capability with detailed system studies, so that an exact value for the energy absorption capability, instead of the line discharge class, is specified by the user here.

When deciding on a definite line discharge class – and thereby indirectly on a definite energy absorption capability – the required MO resistor diameter has also automatically been selected. The following classification is a rough orientation:

MO resistor diameter (mm)	Line discharge class
50	1 and 2
60	2 and 3
70	3 and 4
80	4 and 5
100 (or 2 · 70 in parallel)	5 and higher

After determining the rated voltage and subsequently choosing the MO resistor diameter, the protective characteristic of the arrester has been completely established. All residual voltage values result from the U-I-characteristic of the selected type of MO

¹ According to IEC 60099-5, Table 1.

resistor. The next step is to check whether the retained protective characteristic is adequate.

Selection and Review of the Protective Levels

The protective characteristic of an arrester is most frequently assessed by means of its lightning impulse protective level. That means it is assessed according to its residual voltage while the nominal discharge current is flowing. As already mentioned, according to the application guide of insulation coordination, IEC 60071-2, there must be a factor – the so-called [safety factor](#), K_s – of at least 1.15 between the standard lightning impulse withstand voltage (BIL) of the device to be protected with a non-self-restoring insulation, and the highest lightning overvoltage which is expected to occur at its terminals. In this case it should be noted that, due to traveling wave processes and inductive voltage drops, the voltage at the terminals of the device to be protected can generally be higher than the voltage directly at the arrester terminals. Besides that, it should also be noted that – though very unlikely in high-voltage transmission systems – the discharge current may be higher than the nominal discharge current of the arrester.

If the distance between the arrester and the device is not too great – arresters have a [protective zone](#) of only a few meters in a distribution system and up to about sixty meters in high- and extra-high-voltage systems – this normally means that a protective level equal to the standard lightning impulse withstand voltage of the device to be protected, divided by a factor of 1.4, is adequate in protecting against lightning overvoltages. It should, however, be kept in mind that this simplification might not be adequate for special system configurations and cases of application, or when the distance between the arrester and the device is great. Thus, the correct and standard procedure is to determine the expected overvoltages through calculations and to establish the necessary protective level of the arrester by means of insulation coordination studies. Information and instructions for this are found in the IEC publications 60071-1 and 60071-2, and recommendations for the application of surge arresters are made in IEC 60099-5.

It is common to cite the lightning impulse residual voltage also for the double value of the nominal discharge current. The corresponding values are normally between 5% and 15% above the lightning impulse protective level.

In the extra-high-voltage systems the [switching impulse protective level](#) is normally the determining value of an arrester's protective characteristic. In each case it is gener-

ally cited, in accordance with IEC-standard 60099-4, for two different [switching current impulse](#) values:

Arrester class	Switching current impulses (A)
20 kA, LD-classes 4 and 5	500 and 2000
10 kA, LD-class 3	250 and 1000
10 kA, LD-class 1 and 2	125 and 500

The switching impulse residual voltage is typically between 75 % and 90 % of the 10 kA lightning current impulse residual voltage, depending each time on the MO resistor in use and the actual switching current impulse value. In the case of a 1 kA switching current impulse, one can take 85 % of the 10 kA lightning current impulse residual value as a guideline¹.

Just as with the lightning impulse protective level, the switching impulse protective level is to be selected on the basis that the switching overvoltage on the device to be protected is not higher than its standard switching impulse withstand voltage² divided by the safety factor K_s ($K_s = 1.15$ in the case of non-self-restoring insulation). As a result of the comparatively slow process, voltage increases induced by traveling wave effects or inductive voltage drops, need not be considered. That means that the switching impulse protective level does not need to be lower than the standard switching impulse withstand voltage of the device, divided by a factor of 1.15.

In a few special applications, it is necessary to know the [steep current impulse protective level](#). Thus, it is also typically mentioned in the data sheet of the arrester. The residual voltage of MO resistors is about 5% higher for steep current impulses compared with lightning current impulses of the same value³. However, the published data of the steep current impulse protective level should be interpreted carefully. Basically the residual voltage during steep current rises (front times within the range of $\leq 1 \mu\text{s}$) is influenced by two different effects which nevertheless always occur together. One of these is the fact that the temporal behavior of the MO material during the transition from the non-conducting to a conducting state presents itself, when seen only exter-

¹ Manufacturer-dependent deviations are possible.

² In this context SIL – the basic switching impulse insulation level – is frequently mentioned. This term, found in the US standards, is, however, not defined in the IEC standards (see explanation of [SIL](#) in the appendix).

³ See the chapter on protective characteristics in part 2.

nally, as inductive behavior (the residual voltage peak value lies temporally ahead of the peak value of the current, see [Figure 4](#)). Another is that of the inductivity of the geometrical arrangement having an effect of ca. 1 μH per meter on the overall height. The latter influence can increase the residual voltage by an additional 5 %, or even more. The IEC standard 60099-4 in its present form is not clear on whether both effects are to be treated separately or not, while determining the steep current impulse residual voltage¹. Accordingly, either both parts can be included in the steep current impulse residual voltage, which is cited in the data sheets, or only the temporal behavior of the MO material alone (in which case the geometric influence must have been very carefully compensated during the measurement). If there are any doubts, inquiries should be made.

If, when checking the protective levels of all the cited current impulse stresses, the requirements are fulfilled, then the choice of the electrical characteristic of the arrester is finished at this point. What, however, should be done, if any of these values are too high? For a given type of MO resistor all the residual voltage values, as well as the continuous operating and rated voltage, comprise a fixed ratio. Thus, none of these values can be decreased alone. Instead the whole characteristic would have to be shifted downwards, in order, for example, to obtain a lower switching impulse protective level. This, however, is not allowed, as the continuous operating and rated voltage would also automatically become lower by the same percentage, and a stable continuous operation could no longer be guaranteed. In this case there is normally only one single permissible means: MO resistors with larger cross sections must be selected. This can be achieved by choosing a larger diameter or by connecting several resistors in parallel. Generally it is the case that the ratio of the lightning impulse protective level to the rated voltage is smaller (in other words, the U-I-characteristic is flatter), the bigger the MO resistor cross section is. Therefore, for a given continuous operating and rated voltage, respectively, a larger resistor cross section will result in a lower protective level. The ratio of the residual voltage at a lightning current impulse of 10 kA, to the r.m.s. value of the rated voltage, is between over three in distribution arresters almost down to two for heavy multi-column high-voltage arresters². Requirements for low residual voltage val-

¹ Current version: IEC 60099-4, Edition 1.1, 1998-02. At present "Amendment 2" is being voted upon at the IEC level (Document 37/268/FDIS, voting deadline September 14, 2001) in which, among other things, the procedure for determining the steep current impulse residual voltage will be clearly established.

² The individual factors are naturally very manufacturer-dependent. However, they are established within this range.

ues are thus frequently the reason that larger resistors and greater numbers of them, respectively, are used, than would actually be needed for the required energy absorption capability (or the line discharge class). Therefore, lower residual voltage values should only be requested when they are absolutely necessary for the application in question.

Selecting the Housing

Dielectric and mechanical requirements are generally taken into account when selecting the housing. The length, the creepage distance, the shed profile, the diameter and the material must all be determined. The minimal housing length first of all obviously results from the demand that the MO resistor column (the active part) must fit. The length of this column is determined by the electrical data which was gathered during the selection steps taken up to that point. Normally, however, this is not the dimensioning requirement. Generally further demands cause the housing lengths to be much greater than those of the active parts.

First of all, the clearance which results from the withstand voltage requirements, must be determined. According to IEC 60099-4 the arrester housing must fulfill the following test requirements:

	$I_n = 10 \text{ kA and } 20 \text{ kA}$		$I_n \leq 5 \text{ kA and High Lightning Duty Arresters } (1 \text{ kV} \leq U_s \leq 52 \text{ kV})$
	$U_r \geq 200 \text{ kV}$	$U_r < 200 \text{ kV}$	
Test with lightning impulse voltage	1.3 · lightning impulse protective level		
Test with switching impulse voltage	1.25 · switching impulse protective level	–	–
Test with power-frequency voltage (\hat{u} ; duration 1 min)	–	1.06 · switching impulse protective level	0.88 · lightning impulse protective level

Test voltages resulting from these requirements are below those of the other devices of the system, as the following example of the lightning impulse withstand voltage shows: a typical arrester in a 420-kV-system has a lightning impulse protective level of 823 kV (see Figure 2). Its housing must, therefore, be tested with a lightning impulse voltage of $1.3 \cdot 823 \text{ kV} = 1070 \text{ kV}$, which only comprises 75 % of the standard lightning impulse withstand voltage of 1425 kV, as it is normally applied in this system. This is clearly justified because the arrester housing is the best-protected insulation within the system. No higher voltages occur here other than the voltage drop directly

across the enclosed MO resistors. At the same time the factors cited in the table already take different atmospheric conditions into account – such as installation at heights of up to 1000 m – as well as the possibility of having arrester currents higher than the nominal discharge current. Nevertheless the same withstand voltage values are frequently requested for the arrester housings as those of the rest of the devices, which consequently leads to unnecessarily long housings. The result is then uneconomical and at the same time technically disadvantageous arrester housings¹.

If the site altitude is over 1000 m – which according to the corresponding IEC definition no longer counts as a "normal service condition"² – then greater clearances and housing lengths must be chosen in order to maintain the required withstand voltage values in conditions of lower air density.

A much more frequent reason for longer housings are, however, creepage distance requirements. The shortest possible housing as a result of the length of the active part can normally be achieved only by designing for pollution levels of I or II³, i.e., for specific creepage distances of 16 mm/kV or 20 mm/kV (with reference to U_m). For central European requirements this is often adequate. Worldwide, however, levels III and IV also play an important role. These lead to creepage distance requirements of 25 mm/kV and 31 mm/kV. In addition, there are locations which make the use of even longer creepage distances necessary, for example those with maritime desert climates, or in some cases, these conditions in combination with industrial pollution. In such extreme conditions it should be noted, however, that there are often other, more appropriate means of improving the operational reliability than increasing the creepage distance. For example, one can select a higher continuous operating and rated voltage (naturally, with associated higher protective levels), or use MO resistors with greater diameters, or housings with greater distances between the active part and the housing wall⁴. At any rate one should keep in mind that "artificial" extensions of the active part (by inserting metal spacers), which are brought about by creepage distance extensions, can also have a negative effect on the rest of the operation behavior, as already mentioned in connection with withstand voltage requirements.

¹ Using longer housings can, for example, result in lower short-circuit strength or a disadvantageous voltage distribution along the arrester axis.

² An explanation will be included later in this section.

³ According to the definition in IEC 60815, Table 1.

⁴ More details will be included on this matter in part 2 in the chapter on performance under polluted conditions.

The different shed profiles and some of their characteristics were dealt with in the chapter on "Constructive Design of MO Arresters". A general recommendation for a specific shed profile cannot be given here. When in doubt, in each case, one should be chosen which has proved to be effective in service at the particular site.

After the housing parameters have thus far been determined in order to fulfill the electrical requirements, now in the next and last steps, the mechanical criteria follow. They indirectly lead to the selection of the housing material and the housing diameter. Often there is only a vague idea as to the mechanical stress of an arrester in service, and accordingly no requirements are made, or, maybe even worse, ones in which the values are too high. If there is no information available about the actual requirements, the following values can serve as a guideline for the necessary static head loads: $F_{\text{stat}} = 400$ N up to and including $U_s = 420$ kV, $F_{\text{stat}} = 600$ N for $U_s = 550$ kV and $F_{\text{stat}} = 800$ N for $U_s = 800$ kV. These values represent absolute minimal requirements assuming that the arrester is connected by strain relieving conductor loops and a wind velocity of 34 m/s (≈ 120 km/h) is not exceeded, which according to IEC 60694 belongs to the "normal service conditions".

Besides the static head loads, which normally cause the arrester few problems, dynamic requirements must also be considered. These can, for example, occur as a result of short-circuit currents on the line, or of gusting winds. In this case arresters with porcelain housing can, because of the brittle properties and statistical behavior of the porcelain, be strained at only up to 40 % of its dynamic strength. The specified permissible dynamic head loads should prove, on the other hand, to have at least a 20 % safety margin to the actual breaking values, ascertained during tests¹. The head load values mentioned above are accordingly expanded upon in the following table:

Highest system voltage U_s (kV)	$F_{\text{min, static}}$ (N)	$F_{\text{min, dynamic}}$ (N)	Minimum breaking value (N)
≤ 420	400	1000	1200
550	600	1500	1800
800	800	2000	2400

The ratios look somewhat different for polymer housed arresters. However, appropriate rules and standards have still not been established. At any rate a smaller distance can be adopted between the static and the dynamic loads, since the polymer housing

¹ Data in accordance with DIN 48113 and IEC document 37/268/FDIS.

(with the exception of the cast resin housing, which has brittle characteristics similar to those of porcelain, and thus, is considered in exactly the same manner) diverges less in its mechanical characteristics. According to current findings, a static strength utilization of at least 70 % of the breaking value (whereby the breaking value is, at the same time, difficult to define and determine) is unquestionably permissible. Polymer housings, in contrast to porcelain housings, are visibly deflected under the influence of mechanical forces. Generally, this is not a consideration, however, in those cases in which this sort of behavior would cause problems, choosing a mechanically stronger housing must be considered, which will be less strained under the loads occurring here, and thus be less deflected.

While the values cited in the table indicate relatively minimal demands on the housing strength, these can escalate enormously when taking seismic requirements into account. Such requirements go beyond the "normal operation conditions", and the associated demands must be explicitly described in an enquiry. There are various standardized calculation and test procedures which determine the behavior of an arrester under such conditions¹. Typically a completely assembled arrester is subjected to an earth-



Fig. 21: Polymer housed arrester for a 550-kV-system during seismic testing on a shaking table

¹ See the chapter on seismic performance in part 2.

quake test on a shaking table, on which at least two axes are accelerated at the same time (Figure 21). The excitation may be carried out sinusoidal – temporary or transient – or occur at a spectrum of different frequencies and amplitudes, in order, as nearly as possible, to simulate a real earthquake ("time-history-test"). Extreme requirements can in many cases more easily be fulfilled with the use of polymer housing, than with porcelain housing.

Taking seismic requirements into consideration is a common need for only a few locations worldwide. However, out of the previous list of mechanical characteristics, the short-circuit withstand capability must be considered in every case. It characterizes the failure mode of an arrester after the occurrence of an operational overload of the MO resistors¹. On very rare occasions an overload may occur, for example in a distribution system as a result of a [nearby direct lightning stroke](#) or – even less frequently – because of a power-frequency voltage transfer in a high-voltage system from one system with a higher to another with a lower voltage, caused by a damaged conductor or line galloping. After overloading, an arc develops inside of the arrester housing, through which the site-specific power-frequency short-circuit current flows. In an arrester with an enclosed



Fig. 22: Porcelain housed arrester after pressure relief test with rated short-circuit current (63 kA, 200 ms). With the exception of some sheds which were broken the housing remained intact.

¹ Also see in part 2 "Overloading, short-circuit withstand capability, pressure relief behavior".

gas volume, pressure then increases instantaneously within the inner-housing. Pressure relief devices, however, prevent the housing from exploding. Accordingly, till recently, the relevant IEC-standard¹ thus referred to the "pressure relief behavior" and "pressure relief tests". As the new polymer insulated arresters in part no longer contain enclosed gas volumes in their housing, it makes sense to refer more generally to "short-circuit behavior", and accordingly the associated tests are now called "short-circuit tests". The goal, however, remains the same: in the case of an arrester overloading, according to the test requirements, the housing must either remain intact, or if it breaks, the housing fragments and the ejected parts must fall to the ground within a circumference around the arrester, whose radius is about the same as the height of the arrester. Housing breakage which fulfills these requirements is expressly permissible. Under no circumstances, however, is a violent shattering of the housing allowed, whereby "violent shattering" is defined as occurring when fragments fall outside the area around the arrester in which the parts are required to remain². The chance of a housing breakage must be considered when building a substation. Because of this risk it is generally advisable, for example, to avoid using an arrester as a post insulator for a conductor or a busbar. If this, however, is desired, polymer housed arresters should be used, whereby it should be noted that the required behavior cannot automatically be found in all designs³.

The maximum short-circuit current, flowing for a period of 200 ms, at which an arrester can still fulfill the above mentioned test requirements, was, until recently, divided into different classes in the IEC standards. This was done by giving the short-circuit current a numerical value in kiloamperes, or in some cases, a letter. Today the standard only cites rated short-circuit (withstand) currents given in amperes. The following tables present the classifications according to the old and new standards:

¹ The pressure relief test, including the one for metal-oxide arresters without gaps, is currently only specified in IEC 60099-1. A revision of the test in the form of "Amendment 1" has recently been published (IEC 60099-1 Ed. 3.1., 1999-12). "Amendment 2" to IEC 60099-4, presently being voted upon as document 37/268/FDIS, will include its own section for short-circuit tests for metal-oxide arresters without gaps, but as an Informative Annex only. In both documents the tests have been altered considerably in some important points. For further information refer to part 2.

² This definition is not without its problems. After an otherwise successful short-circuit current test, tiny porcelain pieces are frequently found outside the radius, which were hurled so far only because of the arc-induced pressure wave.

³ For further information see the chapter on polymer housed arresters in part 2.

Old (according to IEC 60099-1, 1991-5):

Pressure relief class	r.m.s. value of the symmetrical short-circuit current (A)
80	80 000
63	63 000
50	50 000
40 (A)	40 000
20 (B)	20 000
10 (C)	10 000
16 (D)	16 000
5 (E)	5 000

New (according to IEC 60099-1, Ed. 3.1, 1999-12):

Rated short-circuit current (A)	r.m.s. value of the symmetrical short-circuit current (A) ¹
80 000	80 000
63 000	63 000
50 000	50 000
40 000	40 000
31 500	31 500
20 000	20 000
16 000	16 000
10 000	10 000
5 000	5 000

The designated pressure relief class or rated short-circuit (withstand) current should at least comply with the maximum short-circuit current expected at the location of the arrester. Not included in the table is the "low short-circuit current" of consistently 800 A according to the old, or 600 A \pm 200 A according to the new standard, which must also be tested in all classes and ratings during the pressure relief test. It flows for a duration of one second, and within this time period the pressure relief devices (if existing in the design) must have opened. This part of the test is carried out to prove that the pressure relief devices of the arrester can also open under very low fault current stress. For polymer housed arresters it also demonstrates the arrester's resistance to fire.

¹ In addition to the test with rated short-circuit current, further tests with current amplitudes of about 50 % and 25 % of this value also have to be performed.

For the high currents, short-circuit withstand capability is tested on the longest unit of a type. For arresters with porcelain housing it is influenced most of all by the following parameters:

- Housing diameter: greater diameters bring about higher strength
- Housing length: the greater the length, the lower the strength at a given diameter
- Wall thickness: strength increases with increasing wall thickness
- Housing material: the porcelain quality "C 120" results in greater strength than quality "C 110"

For the first two parameters the same contexts generally apply for polymer housed arresters. There are, however, other design factors which have an effect (for example, whether it is an arrester with an enclosed gas volume or not), but these will not be dealt with here¹.

At this point the selection of an arrester is complete. Altogether the mechanical requirements – that is, the required head loads, the seismic demands and the short-circuit withstand capability – determine the appropriate combination of housing material, diameter and length. At the same time the length of a porcelain housing is restricted to a size of about two meters for technical and manufacturing reasons. For polymer housed arresters – at least for certain designs – greater lengths are possible and common. If the required total length of an arrester is greater than is possible to enclose in a single housing, then the arrester is made up of several units. It is, however, not only a question of cost – several units means that multiple flanges, sealing systems, pressure relief devices, etc. exist – it is also advantageous to use single unit arresters if they are operated in a heavily polluted environment². At present this is possible for arresters with porcelain housing with a highest system voltage of up to 245 kV and for certain designs of polymer housed arresters at a level of up to 300 kV.

Service Conditions

"Normal service conditions" have been mentioned a few times already. Normally all the characteristic values are only determined for normal service conditions by the manufacturer. Thus, during the selection of an arrester, it is necessary to check whether these

¹ See the chapter on polymer housed arresters in part 2.

² See the chapter on pollution performance in part 2, as well as IEC 60099-4/A1.

conditions apply to the planned installation. The following is a list of normal service conditions¹ found in standard IEC 60099-4, Clause 4.4.1:

- Ambient air temperature within the range of -40°C to $+40^{\circ}\text{C}$
- Solar radiation 1.1 kW/m^2
- Altitude not exceeding 1000 m above sea level
- Frequency of the a.c. power supply not less than 48 Hz and not exceeding 62 Hz
- Power-frequency voltage applied continuously between the terminals of the arrester not exceeding the arrester's continuous operating voltage

Even though it is not currently mentioned in IEC 60099-4, a wind velocity not exceeding 34 m/s, as well as vertical mounting of the arrester, continue to be normal service conditions².

¹ Examples for "abnormal service conditions" are included in Annex A of IEC 60099-4, as well as in document IEC 37/268/FDIS (Amendment 2 to IEC 60099-4), which is presently being voted upon. Also IEC 60099-4, Annex G continues to provide information on enquiries and tenders.

² See IEC 60694 and document IC 37/268/FDIS of July 13, 2001.

Examples

The description of the configuration and selection procedure is now concluded. Below some explanatory numerical examples¹ are provided. They refer to the most common application of arresters between phases and the earth, and are to be understood as standard layouts, as they would have been intended by a manufacturer if no further requirements and information, respectively, are submitted with an arrester enquiry other than that of the system voltage and the type of neutral earthing of the system. At the same time, this represents the minimally required information, without which an arrester cannot be reasonably laid out. It must, however, be noted that based on this scarce information, the resulting arrester will only fulfill the absolute minimum requirements of the system. The characteristic values determined on the basis of so little input data should be carefully checked so that none of the actual system requirements are overlooked. Once again, with reference to IEC 60099-4, Annex G: the more the information and requirements in this annex are specified, the more likely the resulting arrester will fulfill all the demands of the application in question. In special cases a system or insulation coordination study can prove the effectiveness of an arrester layout and the associated achievable protection of the equipment against lightning and switching over-voltage.

The numerical examples below, therefore, represent functioning minimal configurations. However, they are not necessarily typical or common layouts. Instead for good reasons, normally more safety would be provided for. By choosing the continuous operating and the rated voltage higher than is minimally required, it is possible to increase the operational reliability considerably, while in most cases the corresponding increase in the protective level can be tolerated. Some national versions of the application guide IEC 60099-5 – as well as the German – have typical arrester configurations included in their Informative Annex B, from which the most common values for continuous operating and rated voltages and the protective levels for the individual system voltage levels can be obtained.

¹ The resulting characteristic values are to be regarded as reference values; details are naturally manufacturer-specific.

Example 1: "Solidly earthed neutral 66-kV-system"

(All the information which is asterisked (*) are typical. Individually, however, these are manufacturer-dependent values.)

Tacitly assumed, if no further information is given and no special requests are made:

- $U_s = U_m = 72.5 \text{ kV}$
- standard lightning impulse withstand voltage (BIL) of equipment = 325 kV
- earth fault factor $k = 1.4$
- maximum duration of temporary overvoltage: 10 s
- required nominal discharge current $I_n = 10 \text{ kA}$
- required line discharge class: 2
- pollution level I
- maximum short-circuit current: 40 kA

Determining the minimally required continuous operating and rated voltage

- $U_{c, \min} = 1.05 \cdot U_s / \sqrt{3} = 1.05 \cdot 72.5 / \sqrt{3} \text{ kV} = 44 \text{ kV}$
- $U_{rl, \min} = 1.25^* \cdot U_{c, \min} = 1.25^* \cdot 44 \text{ kV} = 55 \text{ kV}$
- $U_{r2, \min} = 1.4 \cdot (U_s / \sqrt{3}) / k_{\text{tov}, 10 \text{ s}} = 1.4 \cdot (72.5 / \sqrt{3}) / 1.075^* \text{ kV} = 55 \text{ kV}$
($k_{\text{tov}, 10 \text{ s}}$ from [Figure 19](#))

Establishing the actual continuous operating and rated voltage:

- $U_r = U_{rl, \min}$ rounded up to the next value divisible by 3 = 57 kV
Normally an arrester with a rated voltage of at least 60 kV is used in this system. This leads to a more stable layout, and nevertheless offers a sufficiently low protective level.
- $U_r = 60 \text{ kV}$
- $U_c = U_r / 1.25^* = 60 \text{ kV} / 1.25^* = 48 \text{ kV}$

Selecting an MO resistor suitable for $I_n = 10 \text{ kA}$ and LD-class 2

- MO diameter: 50* mm
- $\hat{u}_{10 \text{ kA}} / U_r = 2.8^*$ (This factor is characteristic for the MO resistor used when configuring it for the line discharge class 2.)

The resulting protective characteristics*:

- lightning impulse protective level ($\hat{u}_{10 \text{ kA}, 8/20 \mu\text{s}}$): 168 kV
- switching impulse protective level ($\hat{u}_{0.5 \text{ kA}, 30/60 \mu\text{s}}$): 131 kV
- steep current impulse protective level ($\hat{u}_{10 \text{ kA}, 1/2 \mu\text{s}}$): 178 kV

Checking the protective values:

- $BIL/\hat{u}_{10\text{ kA}, 8/20\ \mu\text{s}} = 325\text{ kV}/168\text{ kV} = 1.93 \rightarrow$ definitely sufficient

Height of the MO resistor column:

- $h_{\text{MO}} = 600^*$ mm

Selecting a Housing

Since in this case no further information is available, a housing would be chosen which fulfills the following minimal requirements:

- lightning impulse withstand voltage =
 $1.3 \cdot$ lightning impulse protective level = $1.3 \cdot 168\text{ kV} = 219\text{ kV}$
- power-frequency withstand voltage 1 min, wet =
 $1.06/\sqrt{2} \cdot$ switching impulse protective level = $1.06/\sqrt{2} \cdot 131\text{ kV} = 98\text{ kV}$
- creepage distance: $16\text{ mm/kV} \cdot 72.5\text{ kV} = 1160\text{ mm}$
- permissible head load static: 400 N
- permissible head load dynamic: 1000 N
- rated short-circuit current: 40 kA
- possible length of the active part: 600 mm
- number of units: 1
- grading ring: no

Example 2: "Resonant earthed neutral 110-kV-system"

(All the information which is asterisked (*) are typical. Individually, however, these are manufacturer-dependent values.)

Tacitly assumed, if no further information is given and no special requests are made:

- $U_s = U_m = 123 \text{ kV}$
- standard lightning impulse withstand voltage (BIL) of equipment = 550 kV
- operation under earth fault conditions for > 30 min.
- required nominal discharge current $I_n = 10 \text{ kA}$
- required line discharge class: 2
- pollution level I
- maximum short-circuit current: 40 kA

Determining the minimally required continuous operating and rated voltage

- $U_{c, \min} = U_s = 123 \text{ kV}$
- $U_{r, \min} = 1.25^* \cdot U_{c, \min} = 1.25^* \cdot 123 \text{ kV} = 154 \text{ kV}$
(The rated voltage, however, has no technical significance in a resonant earthed system.)

Establishing the actual continuous operating and rated voltage:

- $U_r = U_{r, \min}$ rounded up to the next value divisible by 3 = 156 kV
- $U_c = U_r / 1.25^* = 156 \text{ kV} / 1.25^* = 124 \text{ kV}^1$

Selecting an MO resistor suitable for $I_n = 10 \text{ kA}$ and LD-class 2

- MO diameter: 60* mm
- $\hat{u}_{10 \text{ kA}} / U_r = 2.35^*$ (This factor is characteristic for the MO resistor used when configuring it for the line discharge class 2.)

Note: Compared with example 1, an MO resistor diameter of 60 mm was chosen here in order to achieve a lower lightning impulse protection level. This is usually a concern in resonant earthed and isolated neutral systems because of the required high continuous operating voltage. Also see example 6, compared with example 7.

¹ Power-frequency voltage values are rounded down to whole numbers.

The resulting protective characteristics*:

- lightning impulse protective level ($\hat{u}_{10 \text{ kA}, 8/20 \mu\text{s}}$): 367 kV¹
(in accordance with the German application guide DIN EN 60099-5/VDE 0675, Part 5: lightning impulse protective level ≤ 370 kV)
- switching impulse protective level ($\hat{u}_{0,5 \text{ kA}, 30/60 \mu\text{s}}$): 294 kV
- steep current impulse protective level ($\hat{u}_{10 \text{ kA}, 1/2 \mu\text{s}}$): 389 kV

Checking the protective values:

- $\text{BIL}/\hat{u}_{10 \text{ kA}, 8/20 \mu\text{s}} = 550 \text{ kV}/367 \text{ kV} = 1.5 \rightarrow$ generally sufficient

Height of the MO resistor column:

- $h_{\text{MO}} = 1260^* \text{ mm}$

Selecting a Housing

Minimal requirements:

- lightning impulse withstand voltage =
 $1.3 \cdot \text{lightning impulse protective level} = 1.3 \cdot 367 \text{ kV} = 447 \text{ kV}$
- power-frequency withstand voltage 1 min, wet =
 $1.06/\sqrt{2} \cdot \text{switching impulse protective level} = 1.06/\sqrt{2} \cdot 294 \text{ kV} = 221 \text{ kV}$
- creepage distance: $16 \text{ mm/kV} \cdot 123 \text{ kV} = 1968 \text{ mm}$
- permissible head load static: 400 N
- permissible head load dynamic: 1000 N
- rated short-circuit current: 40 kA
- possible length of the active part: 1260 mm
- number of units: 1
- grading ring: no

¹ Residual voltage values are rounded up to whole numbers.

Example 3: "Solidly earthed neutral 220-kV-system"

(All the information which is asterisked (*) are typical. Individually, however, these are manufacturer-dependent values.)

Tacitly assumed, if no further information is given and no special requests are made:

- $U_s = U_m = 245$ kV
- standard lightning impulse withstand voltage (BIL) of equipment = 950 kV
- earth fault factor $k = 1.4$
- maximum duration of temporary overvoltage: 10 s
- required nominal discharge current $I_n = 10$ kA
- required line discharge class: 3
- pollution level I
- maximum short-circuit current: 50 kA

Determining the minimally required continuous operating and rated voltage

- $U_{c, \min} = 1.05 \cdot U_s / \sqrt{3} = 1.05 \cdot 245 / \sqrt{3}$ kV = 149 kV
- $U_{rl, \min} = 1.25^* \cdot U_{c, \min} = 1.25^* \cdot 149$ kV = 187 kV
- $U_{r2, \min} = 1.4 \cdot (U_s / \sqrt{3}) / k_{\text{tov}, 10 \text{ s}} = 1.4 \cdot (245 / \sqrt{3}) / 1.075^*$ kV = 185 kV
($k_{\text{tov}, 10 \text{ s}}$ from [Figure 19](#))

Establishing the actual continuous operating and rated voltage:

- $U_r = U_{rl, \min}$ rounded up to the next value divisible by 3 = 189 kV
Normally an arrester with a rated voltage of at least 198 kV is used in this system. This leads to a considerably more stable layout, and nevertheless offers a sufficiently low protective level.
- $U_r = 198$ kV
- $U_c = U_r / 1.25^* = 198 \text{ kV} / 1.25^* = 158$ kV

Selecting an MO resistor suitable for $I_n = 10$ kA and LD-class 3

- MO diameter: 60* mm
- $\hat{u}_{10 \text{ kA}} / U_r = 2.45^*$ (This factor is characteristic for the MO resistor used when configuring it for the line discharge class 3. Compare with example 2!)

The resulting protective characteristics*:

- lightning impulse protective level ($\hat{u}_{10 \text{ kA}, 8/20 \mu\text{s}}$): 485 kV
- switching impulse protective level ($\hat{u}_{1 \text{ kA}, 30/60 \mu\text{s}}$): 402 kV
- steep current impulse protective level ($\hat{u}_{10 \text{ kA}, 1/2 \mu\text{s}}$): 514 kV

Checking the protective values:

- $BIL/\hat{u}_{10\text{ kA}, 8/20\ \mu\text{s}} = 950\text{ kV}/485\text{ kV} = 1.96 \rightarrow$ definitely sufficient

Height of the MO resistor column:

- $h_{MO} = 1670^*$ mm

Selecting a Housing

Minimal requirements:

- lightning impulse withstand voltage =
 $1.3 \cdot \text{lightning impulse protective level} = 1.3 \cdot 485\text{ kV} = 631\text{ kV}$
- power-frequency withstand voltage 1 min, wet =
 $1.06/\sqrt{2} \cdot \text{switching impulse protective level} = 1.06/\sqrt{2} \cdot 402\text{ kV} = 302\text{ kV}$
- creepage distance: $16\text{ mm/kV} \cdot 245\text{ kV} = 3920\text{ mm}$
- permissible head load static: 400 N
- permissible head load dynamic: 1000 N
- rated short-circuit current: 50 kA
- possible length of the active part: 1670 mm
- number of units: 1 (Borderline case when using a porcelain housing!)
- grading ring: no (Borderline case! If this arrester – for example, because of higher creepage distance requirements – were designed in two parts, a grading ring would indeed be required.)

Example 4: "Solidly earthed neutral 380-kV-system; industrial pollution"

(All the information which is asterisked (*) are typical. Individually, however, these are manufacturer-dependent values.)

Tacitly assumed, if no further information is given and no special requests are made:

- $U_s = U_m = 420$ kV
- standard lightning impulse withstand voltage (BIL) of equipment = 1425 kV
- earth fault factor $k = 1.4$
- maximum duration of temporary overvoltage: 10 s
- required nominal discharge current $I_n = 10$ kA
- required line discharge class: 3
- pollution level III
- maximum short-circuit current: 50 kA

Determining the minimally required continuous operating and rated voltage

- $U_{c, \min} = 1.05 \cdot U_s / \sqrt{3} = 1.05 \cdot 420 / \sqrt{3}$ kV = 255 kV
- $U_{rl, \min} = 1.25^* \cdot U_{c, \min} = 1.25^* \cdot 255$ kV = 319 kV
- $U_{r2, \min} = 1.4 \cdot (U_s / \sqrt{3}) / k_{tov, 10 s} = 1.4 \cdot (420 / \sqrt{3}) / 1.075^*$ kV = 316 kV
($k_{tov, 10 s}$ from [Figure 19](#))

Establishing the actual continuous operating and rated voltage:

- $U_r = U_{rl, \min}$ rounded up to the next value divisible by 3 = 321 kV
Normally an arrester with a rated voltage of at least 336 kV is used in this system. This leads to a considerably more stable layout and nevertheless offers a sufficiently low protective level.
- $U_r = 336$ kV
- $U_c = U_r / 1.25^* = 336$ kV / 1.25* = 268 kV

Selecting an MO resistor suitable for $I_n = 10$ kA and LD-class 3

- MO diameter: 60* mm
- $\hat{u}_{10 \text{ kA}} / U_r = 2.45^*$ (This factor is characteristic for the MO resistor used when configuring it for the line discharge class 3. Compare with example 2!)

The resulting protective characteristics*:

- lightning impulse protective level ($\hat{u}_{10 \text{ kA}, 8/20 \mu\text{s}}$): 823 kV
- switching impulse protective level ($\hat{u}_{1 \text{ kA}, 30/60 \mu\text{s}}$): 683 kV
- steep current impulse protective level ($\hat{u}_{10 \text{ kA}, 1/2 \mu\text{s}}$): 872 kV

Checking the protective values:

- $BIL/\hat{u}_{10\text{ kA}, 8/20\ \mu\text{s}} = 1425\text{ kV}/823\text{ kV} = 1.73 \rightarrow$ definitely sufficient

Height of the MO resistor column:

- $h_{\text{MO}} = 2820^*$ mm

Selecting a Housing

Minimal requirements:

- lightning impulse withstand voltage =
 $1.3 \cdot \text{lightning impulse protective level} = 1.3 \cdot 823\text{ kV} = 1070\text{ kV}$
- switching impulse withstand voltage =
 $1.25 \cdot \text{switching impulse protective level} = 1.25 \cdot 683\text{ kV} = 854\text{ kV}$
- creepage distance: $25\text{ mm/kV} \cdot 420\text{ kV} = 10500\text{ mm}$
- permissible head load static: 400 N
- permissible head load dynamic: 1000 N
- rated short-circuit current: 50 kA
- possible length of the active part : 2820 mm (2 · 1410 mm)*
- number of units: 2*
- grading ring: yes

Example 5: "Solidly earthed neutral 500-kV-system; special requirements"

(All the information which is asterisked (*) are typical. Individually, however, these are manufacturer-dependent values.)

Tacitly assumed, if no further information is given and no special requests are made:

- $U_s = U_m = 550$ kV
- standard lightning impulse withstand voltage (BIL) of equipment = 1550 kV
- earth fault factor $k = 1.4$
- maximum duration of temporary overvoltage: 10 s
- required nominal discharge current $I_n = 20$ kA
- required line discharge class: 5
- pollution level I
- maximum short-circuit current: 50 kA

Special information and requirements:

- $U_s = 525$ kV
- switching impulse protective level ($\hat{u}_{2 \text{ kA}, 30/60 \mu\text{s}}$): 760 kV^1
- energy absorption capability ≥ 5 MJ
- creepage distance 25 mm/kV
- seismic withstand capability: ground acceleration 0.5-g acc. to US standard IEEE 693 (\rightarrow arrester base acceleration $1 \cdot g$)²

Determining the minimally required continuous operating and rated voltage

- $U_{c, \min} = 1.05 \cdot U_s / \sqrt{3} = 1.05 \cdot 525 / \sqrt{3} \text{ kV} = 318 \text{ kV}$
- $U_{rl, \min} = 1.25^* \cdot U_{c, \min} = 1.25^* \cdot 318 \text{ kV} = 398 \text{ kV}$
- $U_{r2, \min} = 1.4 \cdot (U_s / \sqrt{3}) / k_{\text{tov}, 10 \text{ s}} = 1.4 \cdot (525 / \sqrt{3}) / 1.075^* \text{ kV} = 395 \text{ kV}$
($k_{\text{tov}, 10 \text{ s}}$ from [Figure 19](#))

¹ Demands for low switching impulse protective levels are typical of extra-high-voltage systems, see chapter "Configuring MO Arresters".

² According to IEEE 693 an arrester's seismic performance is preferably verified by a multi-axes "time history test" on a shaking table. If the arrester is tested without a pedestal (which, for practical reasons, is the usual case) the acceleration at the arrester base must be double the value of the required ground acceleration, assuming an amplification factor of two for a typical pedestal. Furthermore, according to IEEE 693, a mechanical stress of not more than 50 % of the arrester's mechanical breaking strength is allowed to occur during the test. These are the reasons that an extremely high mechanical strength is necessary to fulfill the 0.5-g ground acceleration requirement.

Establishing the actual continuous operating and rated voltage:

- $U_r = U_{rl, \min}$ rounded up to the next value divisible by 3 = 399 kV
- $U_c = U_{c, \min} = 318$ kV

In contrast to the previous examples, the minimum possible continuous operating and rated voltage are actually established here. Otherwise the required extremely low switching impulse protective level could not be attained.

Selecting an MO resistor suitable for $I_n = 20$ kA and LD-class 5

- MO diameter: 100* mm (alternatively: 2 · 70* mm, connected in parallel)
- $\hat{u}_{20 \text{ kA}}/U_r = 2.32*$ (This factor is characteristic for the MO resistor(s) used.)

The resulting protective characteristics*:

- lightning impulse protective level ($\hat{u}_{20 \text{ kA}, 8/20 \mu\text{s}}$): 927 kV
- switching impulse protective level ($\hat{u}_{2 \text{ kA}, 30/60 \mu\text{s}}$): 760 kV
- energy absorption capability (thermal): 18 kJ/kV of $U_r \rightarrow 7.2$ MJ total

Checking the protective values:

- $BIL/\hat{u}_{20 \text{ kA}, 8/20 \mu\text{s}} = 1550 \text{ kV}/927 \text{ kV} = 1.67 \rightarrow$ definitely sufficient
- switching impulse protective level requirement fulfilled
- energy absorption capability requirement fulfilled

Height of the MO resistor column(s):

- $h_{MO} = 3700*$ mm

Selecting a Housing (composite hollow core insulator* in order to fulfill the seismic requirements)

Minimal requirements:

- lightning impulse withstand voltage =
1.3 · lightning impulse protective level = 1.3 · 927 kV = 1205 kV
- switching impulse withstand voltage =
1.25 · switching impulse protective level = 1.25 · 760 kV = 950 kV
- creepage distance: 25 mm/kV · 525 kV = 13125 mm
- permissible head load dynamic: 16400 N (due to seismic requirements!)
- permissible head load static: 11500 N (= 70 % of the dynamic value)
- rated short-circuit current: 50 kA
- possible length of the active part : 3700 mm (2 · 1850 mm)*
- number of units: 2* (in porcelain 3* units would be necessary)
- grading ring: yes

Example 6: "Resonant earthed or isolated neutral 20-kV-system"

(All the information which is asterisked (*) are typical. Individually however, these are manufacturer-dependent values.)

Tacitly assumed, if no further information is given and no special requests are made:

- $U_s = U_m = 24 \text{ kV}$
- standard lightning impulse withstand voltage (BIL) of equipment = 125 kV
- operation under earth fault conditions for > 30 min.
- required nominal discharge current $I_n = 10 \text{ kA}$
- pollution level I
- maximum short-circuit current: 20 kA

Determining the minimally required continuous operating and rated voltage

- $U_{c, \min} = U_s = 24 \text{ kV}$
- $U_{r, \min} = 1.25^* \cdot U_{c, \min} = 1.25^* \cdot 24 \text{ kV} = 30 \text{ kV}$
(The rated voltage, however, has no technical significance in a resonant earthed or isolated system.)

Establishing the actual continuous operating and rated voltage:

- $U_r = U_{r, \min}$ rounded up to the next value divisible by 3 = 30 kV
- $U_c = U_r/1.25^* = 30 \text{ kV}/1.25^* = 24 \text{ kV}$

Selecting an MO resistor suitable for $I_n = 10 \text{ kA}$

- MO diameter: 40* mm
- $\hat{u}_{10 \text{ kA}}/U_r = 2.667^*$ (This factor is characteristic for the MO resistor used if the protective level requirements of central European distribution systems must be met.)

The resulting protective characteristics*:

- lightning impulse protective level ($\hat{u}_{10 \text{ kA}, 8/20 \mu\text{s}}$): 80 kV
(in accordance with the German application guide DIN EN 60099-5/VDE 0675, Part 5: lightning impulse protective level $\leq 80 \text{ kV}$)
- steep current impulse protective level ($\hat{u}_{0,5 \text{ kA}, 30/60 \mu\text{s}}$): 85 kV

Checking the protective values:

- $\text{BIL}/\hat{u}_{10 \text{ kA}, 8/20 \mu\text{s}} = 125 \text{ kV}/80 \text{ kV} = 1.56 \rightarrow \text{sufficient}$

Height of the MO resistor column:

- $h_{MO} = 200^* \text{ mm}$

Selecting a Housing (polymeric type)

Minimal requirements:

- lightning impulse withstand voltage =
 $1.3 \cdot \text{lightning impulse protective level} = 1.3 \cdot 80 \text{ kV} = 104 \text{ kV}$
- power-frequency withstand voltage 1 min, wet =
 $0.88/\sqrt{2} \cdot \text{lightning impulse protective level} = 0.88/\sqrt{2} \cdot 80 \text{ kV} = 50 \text{ kV}$
- creepage distance: $16 \text{ mm/kV} \cdot 24 \text{ kV} = 384 \text{ mm}$
- permissible head load static: 400 N
- permissible head load dynamic: 600 N
- short circuit withstand capability: 20 kA
- possible length of the active part: 200 mm
- number of units: 1 (in medium voltage this is generally the case)
- grading ring: for medium voltage arresters this is generally not necessary

Example 7: "Solidly earthed neutral 20-kV-system"

(All the information which is asterisked (*) are typical. Individually however, these are manufacturer-dependent values.)

Tacitly assumed, if no further information is given and no special requests are made:

- $U_s = U_m = 24 \text{ kV}$
- standard lightning impulse withstand voltage (BIL) of equipment = 125 kV
- earth fault factor $k = 1.4$
- maximum duration of temporary overvoltage: 10 s
- required nominal discharge current $I_n = 10 \text{ kA}$
- pollution level I
- maximum short-circuit current: 20 kA

Determining the minimally required continuous operating and rated voltage

- $U_{c, \min} = 1.05 \cdot U_s / \sqrt{3} = 1.05 \cdot 24 / \sqrt{3} \text{ kV} = 14.6 \text{ kV}$
- $U_{rl, \min} = 1.25^* \cdot U_{c, \min} = 1.25^* \cdot 14.5 \text{ kV} = 18.2 \text{ kV}$
- $U_{r2, \min} = 1.4 \cdot (U_s / \sqrt{3}) / k_{\text{tov}, 10 \text{ s}} = 1.4 \cdot (24 / \sqrt{3}) / 1.0^* \text{ kV} = 19.4 \text{ kV}$
($k_{\text{tov}, 10 \text{ s}}$ is different from that of Figure 19 for the distribution arrester under consideration!)

Establishing the actual continuous operating and rated voltage:

- $U_r = U_{r2, \min}$ rounded up to the next value divisible by 3 = 21 kV
- $U_c = U_r / 1.25^* = 21 \text{ kV} / 1.25^* = 16.8 \text{ kV}$

Selecting an MO resistor suitable for $I_n = 10 \text{ kA}$

- MO diameter: 40* mm
- $\hat{u}_{10 \text{ kA}} / U_r = 2.76^*$ (This factor is characteristic for the MO resistor used if there are no particular protective level requirements.)

The resulting protective characteristics*:

- lightning impulse protective level ($\hat{u}_{10 \text{ kA}, 8/20 \mu\text{s}}$): 58 kV
- steep current impulse protective level ($\hat{u}_{0.5 \text{ kA}, 30/60 \mu\text{s}}$): 62 kV

Checking the protective values:

- $\text{BIL} / \hat{u}_{10 \text{ kA}, 8/20 \mu\text{s}} = 125 \text{ kV} / 58 \text{ kV} = 2.15 \rightarrow$ definitely sufficient

Height of the MO resistor column:

- $h_{MO} = 135^* \text{ mm}$

Selecting a Housing (polymeric type)

Minimal requirements:

- lightning impulse withstand voltage =
 $1.3 \cdot \text{lightning impulse protective level} = 1.3 \cdot 58 \text{ kV} \approx 76 \text{ kV}$
- power-frequency withstand voltage 1 min, wet =
 $0.88/\sqrt{2} \cdot \text{lightning impulse protective level} = 0.88/\sqrt{2} \cdot 58 \text{ kV} \approx 37 \text{ kV}$
- creepage distance: $16 \text{ mm/kV} \cdot 24 \text{ kV} = 384 \text{ mm}$
- permissible head load static: 400 N
- permissible head load dynamic: 600 N
- short circuit withstand capability: 20 kA
- possible length of the active part: 135 mm
- number of units: 1 (in medium voltage this is generally the case)
- grading ring: for medium voltage arresters this is generally not necessary

Standards

The selection below describes the current state of the most important IEC (and some other) standards on arresters and the associated topics. Also some important IEC documents which are currently in the committee draft state are listed.

Since January 1997, the IEC publications have been numbered differently, in order to achieve correspondence to European and international standards. This is done by adding the number 60000 to the old number. The same holds true for the publications published before 1997, even if they currently still have the old number.

The US standards and application guides on arresters and insulation coordination have also been included because of their importance for the American and other national markets.

a) IEC arrester standards and draft documents

IEC 60099-1, Edition 3.1, 1999-12

(Edition 3: 1991 consolidated with amendment 1: 1999)

Surge arresters – Part 1: Non-linear resistor type gapped surge arresters for a.c. systems

IEC 60099-4, Edition 1.1, 1998-08

(Edition 1: 1991 consolidated with amendment 1: 1998)

Surge arresters – Part 4: Metal-oxide surge arresters without gaps for a.c. systems

Note: Amendment 1 is "Annex F (normative): Artificial pollution test with respect to the thermal stress on porcelain-housed multi-unit metal-oxide surge arresters".

IEC 37/268/FDIS, July 13, 2001¹

Amendment 2 to IEC 60099-4 Ed1

¹ The predecessor of this document – 37/231/CDV – was voted on in 16 different fractions. All fractions were basically accepted. In the actual FDIS (Final Draft International Standard) stage all fractions have been put together again. As a major change to the CDV document, however, Clause 7.7 "Short-circuit tests" has become the Informative Annex O, because there is still no final international agreement on the test procedures.

Note: Amendment 2 contains the following new or revised sections, clauses, sub-clauses and annexes:

- Table 1 Arrester classification and test requirements
- 5.4 Internal partial discharges
- 5.14 Mechanical loads
- 7.1 General
- 7.3.1 Steep current impulse residual voltage test
- 7.5.2 Accelerated ageing procedure
- 7.7 Short-circuit tests (→ Informative Annex O)
- 7.8 Internal partial discharge test
- 8.1 Routine tests
- 8.2.1 Standard acceptance tests
- 9 Test requirements on polymer housed surge arresters
- 10 Test requirements on gas-insulated metal-enclosed arresters (GIS-arresters)
- 11 Separable and deadfront arresters
- 12 Liquid immersed arresters
- 13 Mechanical considerations for surge arresters
- Annex L (informative): Ageing test procedure – Arrhenius law – Problems with higher temperatures
- Annex M (informative): Guide for determination of the voltage distribution along metal-oxide surge arresters
- Annex N (normative): Mechanical considerations

IEC 60099-5, Edition 1.1, 2000-03

(Edition 1: 1996 consolidated with amendment 1: 1999)

Surge arresters – Part 5: Selection and application recommendations

Note: Amendment 1 is the new Section 6 "Diagnostic indicators of metal-oxide surge arresters in service".

IEC 37/261/CDV, November 17, 2000

(IEC 60099-6: Surge arresters – Part 6: Surge arresters containing both series and parallel gapped structures – Rated 52 kV and less)

b) IEC standards and draft documents on insulation coordination

IEC 60071-1, Seventh Edition, 1993-12

Insulation co-ordination – Part 1: Definitions, principles and rules

IEC 60071-2, Third Edition, 1996-12

Insulation co-ordination – Part 2: Application guide

IEC 28/138/CD, February 9, 2001

(IEC 60071-4, Ed. 1: Insulation co-ordination – Part 4: Computational Guide to Insulation Co-ordination & Modelling of Electrical Networks)

IEC 28/139/CDV, February 9, 2001

(IEC 60071-5: Insulation co-ordination – Part 5: Procedures for HVDC Converter Stations)

c) Other international and national standards, also relevant for arresters

IEC 60060-1, Second Edition, 1989-11

High-voltage test techniques. Part 1: General definitions and test requirements

IEC 60507, Second edition 1991-04

Artificial pollution tests on high-voltage insulators to be used in a.c. systems

IEC 60672-3, Second Edition, 1997-10

Ceramic and glass-insulating materials – Part 3: Specifications for individual materials

IEC 60694, Second Edition, 1996-05

Common specifications for high-voltage switchgear and control standards

IEC/TR 60815, First edition, 1986-05

Guide for the selection of insulators in respect of polluted conditions

IEC 61166, First Edition, 1993-03

High-voltage alternating current circuit-breakers – Guide for seismic

qualification of high-voltage alternating current circuit-breakers

IEEE Std 693 – 1997

Recommended Practice for Seismic Design of Substations

IEC 36/166/CD, January 28, 2001

(IEC 62073: Guide to the measurement of wettability of insulator surfaces)

HD 637 S1:1999

Power installations exceeding AC 1 kV

IEC 99/35/CD, 1998

Project IEC 61936-1 Ed. 1.0: Power installations exceeding 1 kV a.c. – Part 1:
Common rules

DIN 48 113, September 1973

Stützisolatoren für Schaltgeräte und Schaltanlagen für Spannungen über 1 kV –
Zuordnung der Begriffe für Biegefestigkeit

d) American standards on arresters and insulation coordination

IEEE C62.11-1999

IEEE Standard for Metal-Oxide Surge Arresters for AC Power Circuits (> 1 kV)

Note: This standard, in contrast to IEC 60099-4, applies to both MO arresters
with and without gaps.

IEEE Std. C62.22-1997

IEEE Guide for the Application of Metal-Oxide Surge Arresters for Alternating-
Current Systems

IEEE Standard 1313.1-1996

IEEE Standard for Insulation Coordination – Definitions, Principles, and Rules

IEEE Standard 1313.2-1999

IEEE Guide for the Application of Insulation Coordination

Literature

Consult the following literature for further information on the fundamentals of MO arresters:

E. C. Sakshaug, J. S. Kresge, S. A. Miske

A new Concept in Station Arrester Design

IEEE Transactions on Power Apparatus and Systems, Vol. PAS-96, no. 2, March/April 1977, pp. 647 – 656

CIGRÉ Working Group 33.06

Metal-oxide surge arresters in AC systems

Part 1: General properties of the metal-oxide surge arrester

Part 2: Performance of metal-oxide surge arresters under operating voltage

Part 3: Temporary overvoltages and their stresses on metal-oxide surge arresters

ELECTRA 128, pp. 99-125

CIGRÉ Working Group 33.06

Metal-oxide surge arresters in AC systems

Part 4: Stresses in metal-oxide surge arresters due to temporary harmonic overvoltages

ELECTRA 130, pp. 78-115

CIGRÉ Working Group 33.06

Metal-oxide surge arresters in AC systems

Part 5: Protection performance of metal-oxide surge arresters

Part 6: Selection of metal-oxide surge arrester characteristics from the standards

ELECTRA 133, pp. 133-165

Preview of Part 2 - Selected Topics

The following selection provides an overview of the topics to be covered in the second part of the handbook.

- Historical development of arresters, gapped arresters
- Arrester standards
 - IEC, IEEE/ANSI: current status and developmental tendencies
- Arrester tests
 - type tests
 - routine tests
 - acceptance tests
- Protective characteristics
 - U-I-characteristic in detail
- Energy absorption capability
 - thermal energy absorption capability
 - single impulse energy absorption capability: influence of current waveform
 - a.c. energy absorption capability
 - line discharge class
 - long duration current impulse withstand capability
- Overloading, short-circuit withstand capability, pressure relief behavior
 - IEC test requirements: current and future
 - effect of arrester design on short-circuit withstand capability
 - effect of the current loop (geometrical layout of the circuit)
- Performance in polluted environments
 - effect of housing diameter
 - effect of the distance between the active part and the housing inner wall
 - effect of the creepage distance
 - effect of housing materials: porcelain, silicone rubber, EPDM
 - effect of internal partial discharges
 - effect of higher rated voltage
 - artificial pollution test with respect to thermal stress (Annex F of IEC 60099-4, Ed.1.1)
- Polymer housed arresters
 - differences in design
 - use of composite hollow core insulators

- directly wrapped designs
- directly molded designs
- mechanical strength
 - definition according to IEC 60099-4/A2
 - achievable strength
 - seismic performance
- overload performance (short-circuit withstand capability, failure mode)
- differences in material
 - silicone rubber: RTV, LSR/LR, HTV
 - EPDM
 - blends
- special tests according to IEC 60099-4/A2
- station layout using arresters with composite hollow core insulator housings
- Seismic performance
 - requirements (standards)
 - calculation methods
 - test methods
- Voltage and temperature distribution on arresters
 - causes, influences, countermeasures (external grading system)
 - differences between voltage and temperature distribution
 - measuring methods
 - calculation methods
- Properties and production of MO resistors
- Life span, reliability, and failure rates of arresters
- Special applications when using standard arresters
- Generator protection arresters
- Gas-insulated metal-enclosed (GIS) arresters
- Arresters for protection of series compensation capacitors
 - increase of energy absorption capability through parallel connection
 - achieving uniform current distribution
 - overload performance
- Arresters for HVDC applications
 - valve protection arresters
 - problems related to d.c. voltage stress

- Limiters
- Separable and deadfront arresters
- Arresters for traction systems (fixed installations, locomotives)
- Combined arresters
 - in the disconnecter
 - in the bushing
 - as a station post insulator
- Arrester monitoring
 - monitoring parameters
 - single impulse overloading
 - thermal instability (thermal runaway)
 - different types of electrical ageing (degradation)
 - monitoring procedures
 - surge counters
 - leakage current indicators (peak value, r.m.s. value, arithmetic mean value)
 - monitoring spark gaps
 - leakage current analysis
 - measuring the resistive component
 - measuring the power loss
 - determining the third harmonics content
 - "virtual reference" procedure
 - temperature monitoring with remote wireless surface acoustic wave sensors (SAW sensors)

Appendix: MO Arresters in Brief

This part of the arrester handbook explains the most important terms used in arrester technology and others associated with this technology. Further information will be available in the second part of the handbook or in the standards to which reference is made under the different terms¹.

Abnormal service conditions: are defined in IEC 60099-4, Annex A, as well as in document IEC 37/268/FDIS (Amendment 2 of IEC 60099-4), sub-clause 13.4.2. "Typical information given with enquiries and tenders" is also included in IEC 60099-4, Annex G. Also see →[Normal service conditions](#).

Acceptance tests: According to IEC 60099-4, the following standard tests are carried out on MO arresters without gaps, if acceptance tests have been arranged for. They must be performed on the nearest lower whole number to the cube root of the total quantity of arresters to be supplied:

- Measurement of power-frequency voltage on the complete arrester at the →[reference current](#)
- Measurement of the →[lightning impulse residual voltage](#) on the complete arrester or on the individual →[arrester units](#), if possible at →[nominal discharge current](#)
- →[Partial discharge test](#) on the complete arrester or on the individual →[arrester units](#)
- Tightness test

Active part of an arrester: the MO resistor column(s) of an arrester, including metallic spacers and the supporting construction.

Alumina porcelain: a type of porcelain in accordance with subgroup "C 120: aluminous porcelains" of the standard IEC 60672-3.

Arrester disconnecter: →[Disconnecter](#)

Arrester section: →[Section of an arrester](#)

Arrester unit: →[Unit of an arrester](#)

¹ Underlined terms represent keywords which are further explained in greater detail. In the electronic version of the handbook, clicking on the terms will automatically call up the definitions.

Back flashover: flashover of a line insulator caused by the potential rise of a tower or pole during a lightning stroke to the overhead ground or shield wire, or to the tower or pole itself. Back flashovers are particularly common when high tower footing impedances are present, since they cause high voltage drops during the flow of lightning discharge current.

Basic lightning impulse insulation level: →[BIL](#)

Basic switching impulse insulation level: →[SIL](#)

BIL: abbreviation for "basic lightning impulse insulation level". Even though this term is frequently used when referring to IEC standards, it is only defined by IEEE and ANSI (see standards IEEE Std 1313.1-1996, IEEE Std C62.2-1987, IEEE Std C62.22-1997, ANSI C92.1-1982). The IEC standard 60071-1, Seventh edition, 1993-12, uses the term →[standard lightning impulse withstand voltage](#) instead.

C 110: →[Quartz porcelain](#)

C 120: →[Alumina porcelain](#)

Composite hollow core insulator: a hollow core insulator made out of an →[FRP](#) tube with applied polymeric sheds. The FRP tube can be of the →[wet-processed](#) or →[vacuum-impregnated](#) type. The sheds almost always consist of →[silicone rubber](#), with differences between →[RTV silicone rubber](#), →[HTV silicone rubber](#), and →[LSR/LR](#). They are applied using different manufacturing processes: →[push-on method](#), →[direct molding](#).

Conditioning: Conditioning is a part of the →[operating duty test](#) and takes place before the actual proof of →[thermal stability](#), after energy has been injected. It should cause possible →[electrical ageing](#) (degradation) to occur, so that the actual operating duty test is not carried out in a simplified manner on brand new MO resistors. The conditioning consists of twenty →[lightning current impulse](#) stresses of →[nominal discharge current](#), which are superimposed on an applied power-frequency voltage with 1.2 times the →[continuous operating voltage](#). For the operating duty test on arresters of →[line discharge classes](#) 2 to 5, two consecutive →[high current impulses](#) with 100 kA peak value each, are additionally applied.

Continuous operating voltage of an arrester: (symbol: U_c) The continuous operating voltage is the designated permissible root-mean-square value of power-frequency volt-

age, which is allowed to continuously be applied between the arrester terminals (IEC 60099-4, clause 2.9).

Coordination withstand voltage: a term from the →[insulation coordination](#): value of the →[withstand voltage](#) of an insulation configuration in actual service conditions, for which an acceptable failure rate (the so-called "performance criterion") results. The application of surge arresters ensures that the value of the coordination withstand voltage is never exceeded at the terminals of the device to be protected. For an exact definition of the terms mentioned above, and their meaning and determination during the process of insulation coordination, see IEC 60071-1 and 60071-2.

Current impulse: unidirectional current impulse, which ideally increases quickly to a peak value and then – generally more slowly – returns to zero. The parameters which define a current impulse are polarity, peak value, →[virtual front time](#) T_1 and →[virtual time to half-value on the tail](#) T_2 in microseconds (exception: →[long duration current impulse](#), which is characterized by polarity, peak value, virtual duration of the peak and virtual total duration). This is represented as T_1/T_2 , without information about the time unit. For example, the →[lightning current impulse](#) ($T_1 = 8 \mu\text{s}$, $T_2 = 20 \mu\text{s}$) is described as a current of the form 8/20.

Degradation: →[Electrical ageing](#)

DIN: Abbreviation for "Deutsches Institut für Normung e.V.", a German organization for standardization based in Berlin.

Direct molding: a means of putting silicone sheds on an arrester or on the FRP core of a →[composite hollow core insulator](#) or composite line insulator (as opposed to the →[push-on method](#)). In this case different technologies are utilized. Most frequently the body which is to be recast is set in a tightly closed lengthwise-divided mold, and completely recast in one pouring. This is possible and usual for lengths of up to about two meters. For even longer bodies the sheds are raised in several pourings, one after another, whereby each segment is →[vulcanized](#) to the previous one. The resulting encapsulation creates two lengthwise molding lines (frequently, but mistakenly, called "seams"). However, if this is carried out carefully, it does not negatively affect the operating behavior. In a different procedure the encapsulation is accomplished by raising the sheds one after another, by means of a one-piece form, which surrounds the body in a ring, and which is passed along the body step by step. Another known procedure is that in which the silicone rubber is raised spirally with a form which moves along the rotating body. The result is not single separate sheds, but instead one continuous spiral.

Discharge voltage: → [Residual voltage](#)

Disconnecter: a device at the earth terminal of the arrester, which separates the arrester from the system after an overloading. This is especially important in conjunction with polymer housed arresters, since their housing does not decay during a failure, and the puncture and flashover channels as well as black carbon and burn traces then form an earth fault (while a porcelain arrester often totally breaks apart, thereby becoming isolated from the line). Without a disconnecter – at least in a solidly earthed neutral system – a subsequent operation of the appropriate line section would no longer be possible. One disadvantage, however, is that after the disconnection of the arrester – which often goes unnoticed – protection against overvoltage is no longer feasible. Disconnecters are only installed in distribution systems or in association with → [line arresters](#). One of the most common working principles of disconnecters currently being manufactured is the ignition of a small explosive device (e.g., the cartridge of a gas pistol) caused by the thermal effect of the power-frequency earth fault current, which flows after an arrester failure. The explosive device tears the surrounding polymeric housing and causes the flexible earthing lead to disconnect from the arrester:

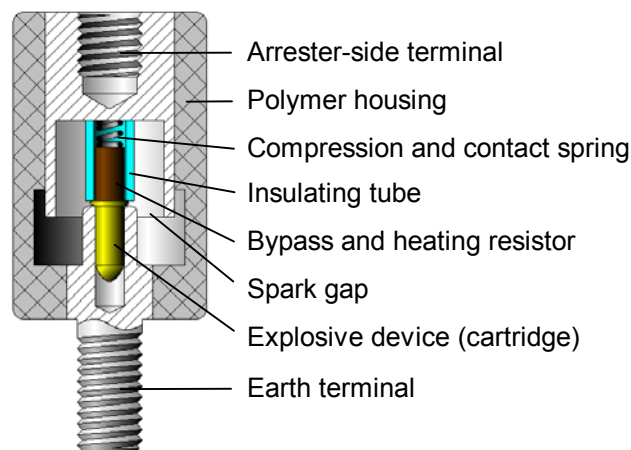

Distributed constant impulse generator: generator to simulate the equivalent circuit of a line by distributed, series connected → [\$\pi\$ -elements](#) (series inductors and shunt capacitors). In current impulse laboratories for arrester testing, distributed constant impulse generators are used for the → [long duration current impulse withstand test](#) (IEC 60099-4, sub-clause 7.4.3), the → [line discharge test](#) (IEC 60099-4, sub-clause 7.4.2) and the → [switching surge operating duty test](#) (IEC 60099-4, sub-clause 7.5.5). An example of a distributed constant impulse generator is given in IEC 60099-4, Annex J.

Earth fault factor: (symbol: k) at a given location, the ratio of the root-mean-square value of the highest power-frequency phase-to-earth voltage on a healthy phase during

an earth fault, affecting one or more phases at any point on the system, to the root-mean-square value of the power-frequency phase-to-earth voltage which would be obtained at the given location in the absence of any such fault (IEC 60071-1, clause 3.15). The earth fault factor only refers to a particular point of a three-phase system, and to a particular system condition. The magnitude of the earth fault factor depends on the way the neutrals of a system are earthed: $k \leq 1.4$ for a [→solidly earthed neutral system](#), and $k \geq 1.73$ for [→resonant earthed](#) or [→isolated neutral](#) systems.

Electrical ageing: (also: degradation) changes (or rather, deterioration) of the [→voltage-current-characteristic](#) of an MO resistor or arrester in the [→leakage current](#) region. With the level of technology used to manufacture MO resistors today, and under energy stress within the manufacturers' specified limits, electrical ageing is not to be expected. It can, however, occur under conditions of extraordinarily high current impulse stress. Also, certain compounds in the gaseous atmosphere surrounding the MO resistors, or other solid or liquid insulating materials in direct contact with the resistors can, through chemical influences, cause electrical ageing, if no direct measures are undertaken to prevent this during development and production of the MO resistors and the arresters. Electrical ageing is partially reversible (the voltage-current-characteristic "recovers").

Energy absorption capability: [→Single impulse energy absorption capability](#), [→Thermal energy absorption capability](#), [→Line discharge class](#)

Fast-front overvoltage: transient overvoltage, normally unidirectional, with time to peak of greater than 0.1 μs up to and including 20 μs , and tail duration below 300 μs (IEC 60071-1, clause 3.17).

Fiber-glass reinforced plastic: (abbreviated: FRP) This material is frequently utilized in an arrester for the MO resistor column supporting construction. In polymer housed arresters it is the most important component for achieving the mechanical strength of the housing, e.g., in the form of rods, loops, tubes or wound mats.

FRP: [→Fiber-glass reinforced plastic](#)

Gapped arrester: an arrester having one or more gaps in series with one or more non-linear resistors (IEC 60099-1, clause 2.2). Even though there are also metal-oxide arresters with gaps, internal as well as external ones ([→line arrester](#)), and even though there are also designs with shunt gaps (which are connected in parallel to the non-linear resistors), generally a "gapped arrester" is used to describe only those silicon-carbide

(SiC) arresters with internal series gaps, which were in use before the introduction of the metal-oxide arresters without gaps.

Guaranteed creepage distance: creepage distance of an insulator as guaranteed by the manufacturer, taking into account possible dimensional tolerances which originate in the manufacturing process; normally a few percent less than the → [nominal creepage distance](#)

High current impulse: peak value of a → [current impulse](#) 4/10, used to test the stability of an arrester on nearby direct lightning strokes (IEC 60099-4, clause 2.31). It should be noted, however, that a high current impulse with an amplitude of, for example, 100 kA, has little to do with a real lightning discharge current at the same value, which can last several ten to hundred microseconds. Especially while testing arresters with MO resistors of more than 40 mm in diameter, is the high impulse current then less an energy, and much more a dielectric stress (because of the extraordinarily high → [residual voltage](#)). High current impulses are needed in the laboratory for the → [operating duty tests](#) on arresters or → [arrester sections](#). They are produced by a capacitor discharge in an aperiodically damped RLC circuit. The current amplitude is within a range of 10 kA to 100 kA (see IEC 60099-4, Table 6). The following oscillogram illustrates an example of a high current impulse test on an arrester section at a current amplitude of 100 kA:

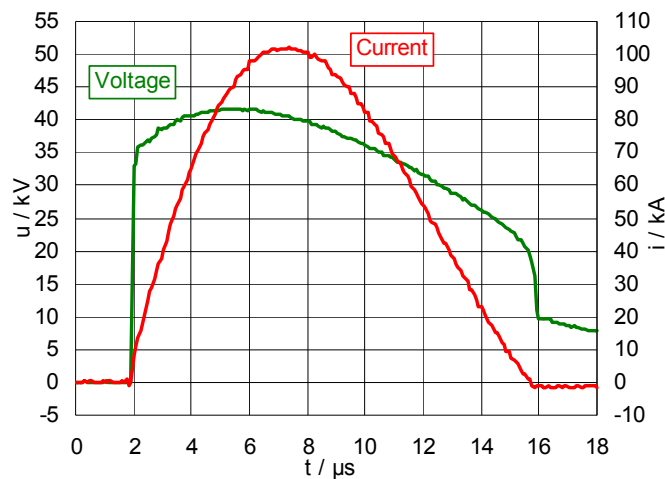

High current impulse operating duty test: see IEC 60099-4, sub-clause 7.5.4. To be carried out on all arresters with → [nominal discharge current](#) of 1.5 kA, 2.5 kA or 5 kA and on arresters with nominal discharge current of 10 kA and → [line discharge class](#) 1. The sequence is schematically depicted in the diagram following at the end of this paragraph. Also the 20-kA High Lightning Duty arresters for the voltage range 1 kV to 52 kV are subjected to a high current impulse operating duty test. However, it is carried out in a different sequence (see IEC 60099-4, Annex C).

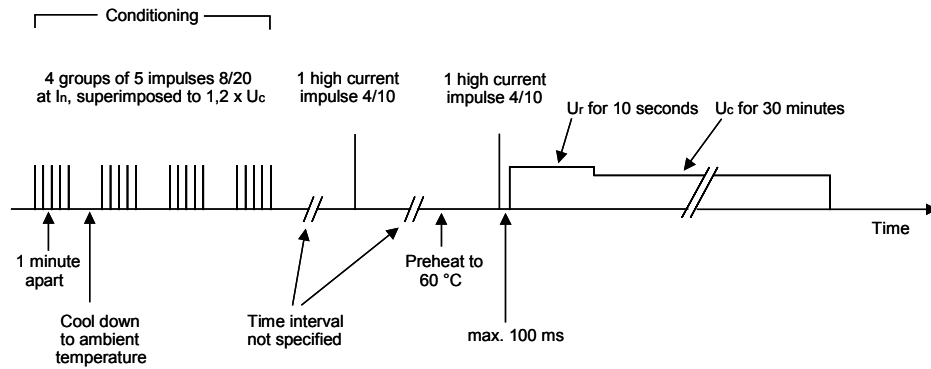

Highest system voltage: → [Highest voltage of a system](#)

Highest voltage for equipment: (symbol: U_m) root-mean-square value of the highest phase-to-phase voltage for which the equipment is designed with reference to its insulation and other characteristics which relate to this voltage in the relevant equipment standard (IEC 60071-1, clause 3.10).

Highest voltage of a system: (symbol: U_s) the highest value of operating voltage which occurs under normal operating conditions at any time and at any point in the system (IEC 60071-1, clause 3.9; the symbol U_s is found in IEC 60071-2, clause 1.3).

HTV silicone rubber: High temperature vulcanizing silicone rubber. A single component type of → [silicone rubber](#), which is delivered in extremely high viscous conditions (comparable to natural rubber). It is injected into the mold under high pressures (several ten MPa) and temperatures ($> 150\text{ °C}$) and finally → [vulcanized](#) at similarly high temperatures.

Hydrophobicity: the characteristic of repelling water. No closed water film can form on a hydrophobic surface. Instead water on the surface pulls together to form single droplets and drips off the surface. According to a proposal of the Swedish Transmission Research Institute ("STRI guide 92/1: Hydrophobicity classification guide"), the degree of hydrophobicity is divided into seven classes (HC 1 to HC 7), where HC 1 corresponds to a completely hydrophobic and HC 7 to a completely hydrophilic (easily wetted) surface. This classification has recently been adopted to become part of an IEC standard (Committee Draft IEC 36/166/CD, 28 January, 2001: "IEC 62073: Guide to the measurement of wettability of insulator surfaces"; refer to this for further information on hydrophobicity). A material for which hydrophobicity is particularly characteristic is → [silicone rubber](#).

IEC: Abbreviation for "International Electrotechnical Commission". Commission for the worldwide standardization in the area of electrotechnology, with headquarter in Geneva, Switzerland.

IEEE: Abbreviation for "Institute of Electrical and Electronics Engineers", an American organization which, besides other tasks, develops standards on the field of electrical and information technology, based in New York City, USA.

Impedance earthed neutral system: a system in which one or more neutral points are earthed through an impedance to limit earth fault currents (IEC 60071-1, clause 3.13).

I_n : → [Nominal discharge current](#)

Inductance of an arrester: MO resistors, when stressed by otherwise equal current amplitudes, exhibit increasing residual voltage with greater front steepness of the current impulse. Thus, in the case of → [steep current impulse](#) stress, a 5 % increase in residual voltage is expected compared with that under equally high lightning current impulse stress. In addition, however, for very short rise times of the discharge current (front times of less than about 1 μ s) inductive voltage drops due to the spatial expansion of the arrester, must be taken into account. For outdoor arresters the inductance of a straight, stretched line with large clearance to other lines or earthed parts may be assumed. An arrangement like this has an inductance of about 1 μ H/m. At the same time, only 0.3 μ H/m is effective for a gas-insulated, metal-enclosed arrester because of its coaxial design. When viewing the protective level for steep current impulse stress in its entirety, the inductance of the connecting leads between overhead line conductor and arrester high-voltage terminal, as well as between its earthing terminal and effective station earth, must also be considered (see [Figure 6](#)).

Insulation coordination: the selection of the dielectric strength of equipment in relation to the voltages which can appear on the system for which the equipment is intended, while taking the service environment and the characteristics of the available overvoltage protective devices into account (IEC 60071-1, clause 3.1)

I_s : According to draft document 37/268/FDIS of July 2001 (clause 7.7 and Annex O: → [short-circuit tests](#)), I_s is the symbol for the → [rated short-circuit \(withstand\) current](#). In the already published standard IEC 60099-1, Ed. 3.1, 1999-12 for gapped arresters, the term rated short-circuit (withstand) current has already been introduced, however not the corresponding symbol.

Isokeraunic: → [Keraunic level](#)

Isolated neutral system: a system in which the neutral points are not intentionally earthed, except for high impedance connections for protection or measurement purposes (IEC 60071-1, 3.11).

Keraunic level: (frequently, but mistakenly called isokeraunic level) the average number of thunderstorm days per year. From the keraunic level the ground flash density and consequently the expected arrester stress in the system can be deduced.

K_s : → [Safety factor \$K_s\$](#)

Leakage current: current which flows through the arrester at continuously applied power-frequency voltage. At alternating voltage it consists of a strongly capacitive and a considerably smaller resistive component, both of which depend on the MO resistors used. The capacitive part is heavily affected by stray capacitances and therefore also depends on the actual location of the arrester and on its overall dimensions. The peak value of the leakage current, as measured on site, is usually within the range of 0.5 mA to 2 mA.

Leakage current indicator: a device attached to the outside of the arrester (see picture), which measures the → [leakage current](#) flowing through the arrester. Usually the peak value of the current is recorded. Either the peak value itself or an apparent root-mean-square value over a scaling factor is indicated. Most leakage current indicators are combined with a → [surge counter](#) in the same housing (see picture below). Leakage current indicators are series-connected with the arrester in its earth connection. This requires installation of the arrester isolated from the ground by means of insulating feet.



Lightning current impulse: → [current impulse](#) 8/20 with a → [front time](#) between 7 μs and 9 μs and a → [time to half-value on the tail](#) between 18 μs and 22 μs (IEC 60099-4, clause 2.17). Lightning current impulses are used in the laboratory to ascertain the → [voltage-current-characteristic](#) of arresters, → [arrester sections](#) or → [MO resistors](#), as well as during the → [conditioning](#) as part of the → [operating duty test](#). They are produced by a capacitor discharge in an aperiodically damped RLC circuit. The current amplitudes are within a range of 100 A to 40 kA. The oscillogram depicts an example of a residual voltage measurement on an MO resistor at a lightning current impulse of 10 kA:

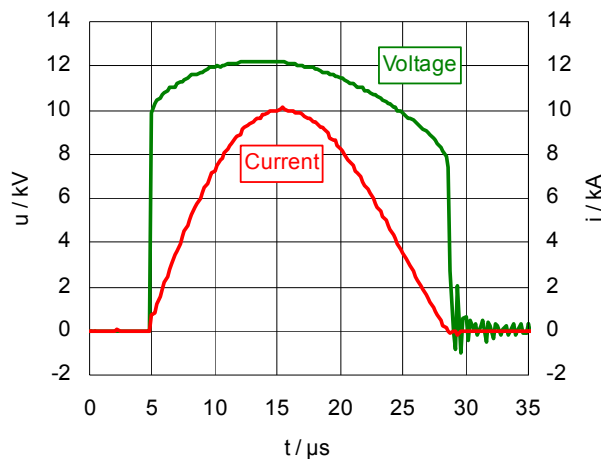

Lightning impulse protective level: maximum value of the → [residual voltage](#) of an arrester at → [nominal discharge current](#).

Lightning impulse residual voltage: → [residual voltage](#) of an arrester, → [arrester unit](#), → [arrester section](#) or → [MO resistor](#) at → [lightning current impulse](#).

Lightning overvoltage: transient overvoltage caused by direct lightning stroke to an overhead line conductor, a shield wire or a tower, or induced by lightning currents in neighboring lines or metal structures. Most of the lightning strokes (80 % ... 90 %) have a negative polarity. The currents are normally within the range of 30 kA to 50 kA, with measured maximum values of more than 300 kA. The front time is only a few microseconds, the total duration about 10 μs to 100 μs . Normally a lightning flash consists of multiple strokes which occur at intervals of about 5 ms to 200 ms, using the same path as the initial stroke. The level of overvoltage caused by a lightning stroke results from the lightning current impulse amplitude and the → [surge impedance](#) of the line and amounts to several million volts. However when a flashover occurs along a line insulator, the level is actually limited to the value of the insulator flashover voltage. Only these overvoltages run into the substation and have to continue to be limited by the

arresters installed there. Lightning overvoltage belongs to the class of → [fast-front over-voltages](#), according to IEC 60071-1, clause 3.17.

Line arrester: also: transmission line arrester (TLA) or transmission line surge arrester (TLSA); arrester which is installed in an overhead line in parallel to a line insulator to prevent flashovers of the insulator. Line arresters are preferably installed where frequent → [back flashovers](#) occur due to missing or inadequate overhead ground or shield wire protection and/or high tower footing impedances (e.g. in rocky terrain). In order to improve the supply quality of an already existing transmission or distribution line, installing line arresters on all, or only on some, of the towers or poles is in many cases a cost-saving alternative to improving the shielding of the line or the grounding of towers or poles. Line arresters are used not only in gapless technology, but also in conjunction with an external serial spark gap, which insulates the arrester from the line during normal operation (and after overloading).

Line discharge class: The line discharge class is the only possibility in IEC 60099-4 to specify the energy absorption capability of an arrester. There are five line discharge classes (1 to 5) which are defined by increasing demands on the energy absorption capability. They differ according to the testing parameters in the → [line discharge test](#) (IEC 60099-4, Table 4). The → [thermal energy absorption capability](#) of an arrester can be derived from its line discharge class in conjunction with the → [switching impulse residual voltage](#) (see IEC 60099-4, Annex E). Also see [Figure 20](#) with the accompanying explanation.

Line discharge test: The line discharge test is a special form of the → [long duration current impulse withstand test](#). In this test (IEC 60099-4, sub-clause 7.4.2), an arrester, an → [arrester section](#), or a single → [MO resistor](#) is exposed to 18 → [long duration current impulses](#), which are in detail specified in IEC 60099-4, Table 4. The test is considered passed if the resistors show no evidence of puncture, flashover, cracking or other significant damage and their → [lightning impulse residual voltage](#) at → [nominal discharge current](#) has not changed by more than 5%.

Long duration current impulse: → a rectangular current impulse, which quickly rises to its maximum value, remains substantially constant for a specified time period, and then quickly falls to zero. Characteristic parameters of a long duration current impulse include polarity, peak value, virtual duration of the peak and virtual total duration (IEC 60099-4, clause 2.18). Long duration current impulses are needed in laboratories for the → [long duration current impulse withstand test](#) and the → [switching surge operating duty test](#) on individual → [MO resistors](#), → [arrester sections](#) or arresters. They are usually

generated by the discharge of a →[distributed constant impulse generator](#), which is made up of capacitors and air-core inductors. The current impulses have peak values of up to 2 kA and virtual total durations of up to several milliseconds. The following oscillogram depicts an example of a long duration current impulse withstand test on an arrester section with a current peak value of about 700 A and a virtual duration of the peak of 2.4 ms (corresponds to the typical current form of a →[line discharge test](#) for →[line discharge class 3](#)) :

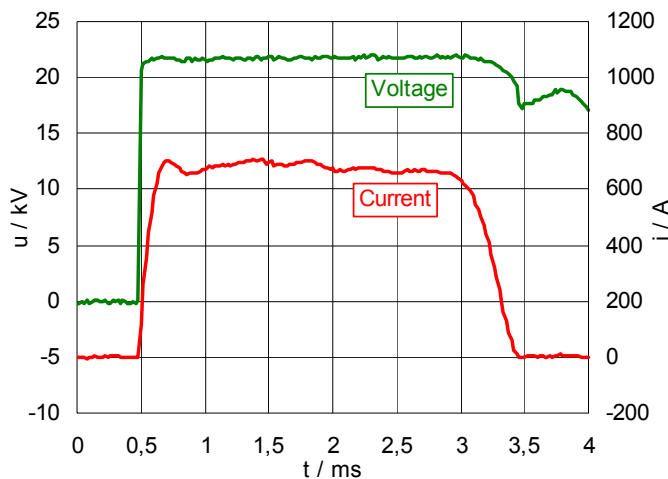

Long duration current impulse withstand capability: This is not a standard IEC 60099-4 term. It is, however, listed by practically all the manufacturers, since it is a good measure of the →[single impulse energy absorption capability](#) (which is also not defined in IEC 60099-4). It is generally common to list the long duration current impulse withstand capability as a maximum permitted →[long duration current impulse](#) of a virtual duration of peak of 2 ms or 2.4 ms. At this current single MO resistors are stressed eighteen times in succession following the test specification of the →[long duration current impulse withstand test](#). The test is considered passed if the resistors show no evidence of puncture, flashover, cracking or other significant damage and their →[lightning impulse residual voltage](#) at →[nominal discharge current](#) has not changed by more than 5%.

Long duration current impulse withstand test: This test, according to IEC 60099-4, clause 7.4, serves – indirectly – as a proof of the →[single impulse energy absorption capability](#), though this is not defined in the IEC standard. The test is carried out on individual MO resistors in open air according to the following diagram:

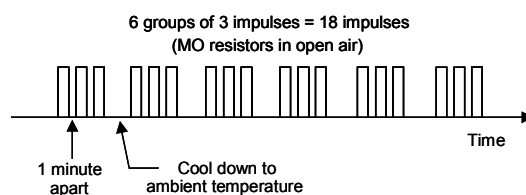

The test is considered passed if the resistors show no evidence of puncture, flashover, cracking or other significant damage and their →[lightning impulse residual voltage](#) at →[nominal discharge current](#) has not changed by more than 5%.

LR: →[LSR](#)

LSR: (also known as LR) abbreviation for liquid silicone rubber. A type of silicone rubber which is delivered in a state of medium viscosity. It is mixed out of two components in more or less equal parts and can be filled into molds under moderate pressure at process temperatures ranging from 110 °C to 200 °C. LSR is increasingly replacing the widely used →[RTV silicone rubber](#), since it is more economical to purchase and process and has similarly good operating characteristics.

MCOV: (abbreviation for: maximum continuous operating voltage) a term which is only defined in the American arrester standard IEEE Std C62.11-1999 as, "the maximum designated root-mean-square (rms) value of power-frequency voltage that may be applied continuously between the terminals of the arrester". Corresponds to the continuous operating voltage U_c , according to IEC 60099-4.

Metal-oxide arrester: (more precisely: metal-oxide arrester without gaps) According to IEC 60099-4, clause 2.1, an arrester with non-linear (voltage-dependent) →[metal-oxide resistors](#), which are connected in series or in parallel without any integrated series or parallel gaps. According to the American arrester standard IEEE C62.11, clause 3.51, however, a "metal-oxide surge arrester (MOSA)" is not automatically a gapless arrester but may contain internal series or parallel gaps.

Metal-oxide resistor: (MO resistor) resistor with an extremely non-linear voltage-current-characteristic. All resistors currently designated as metal-oxide resistors consist of about 90 % zinc-oxide (ZnO; consequently, the metal-oxide arrester is occasionally called a ZnO arrester). The other 10 % is composed of about 10 different additives in the form of the oxides of rare earths (Bi, Sb, Co, Mn), which finally make up anywhere between a few ppm and up to a few percent of the total mass. The components are carefully milled into powder and mixed. A slurry is prepared from the powder, which is granulated and pressed into cylindrical (sometimes also toroidal) forms, dried and then sintered to a homogenous ceramic at temperatures of up to 1200 °C. The end faces are lapped or grinded, afterwards plated with aluminum or zinc, and finally the circumference is coated (e.g., glazed). The common dimensions of metal-oxide resistors currently being manufactured include diameters of between about 30 mm and 100 mm; the height is at the most ca. 45 mm.

Metal-oxide surge arrester: → [Metal-oxide arrester](#)

MO arrester: → [Metal-oxide arrester](#)

MO resistor: → [Metal-oxide resistor](#)

Monitoring spark gap: a device which is attached to the outside of the arrester, whose removable control electrodes record, by means of sparkover marks, the number, intensity (amplitude and duration) and polarity of arrester operations. Monitoring spark gaps are series-connected with the arrester in its earth connection. This requires installation of the arrester isolated from the ground by means of insulating feet. The three pictures show a monitoring spark gap mounted on an arrester (top left), in opened condition with the control electrodes removed (top right), as well as examples of sparkover marks on the control electrodes (below).



MOSA: → [Metal-oxide arrester](#)

Nearby direct lightning stroke: This term, in the arrester context, refers to lightning which directly strikes an overhead line conductor at a point which is so close to an arrester that an insulator flashover does not occur before the overvoltage surge – in the form of a traveling wave – reaches the arrester. This frequently happens in distribution systems and usually destroys the affected arrester. Arresters – particularly station arresters – are normally configured with the assumption that the greatest part of the contained charge in the lightning discharge is already diverted to ground by means of flashed over line insulators before it reaches the arrester.

NEMA: Abbreviation for "National Electrical Manufacturers Association", an American organization for developing standards for the electrical manufacturing industry, based in Rosslyn, Virginia, USA.

Neutral earthing of a system: Power transmission and distribution systems, depending on how the neutral points are connected to earth (if at all), are categorized into →[isolated neutral systems](#), →[solidly earthed neutral systems](#), →[impedance earthed neutral systems](#) and →[resonant earthed neutral systems](#).

Nominal creepage distance: the creepage distance assigned to an insulator. The actual creepage distance may deviate by a few percent more or less, as a result of manufacturing tolerances. Also see →[guaranteed creepage distance](#).

Nominal discharge current: the peak value of a →[lightning current impulse](#) which is used to classify an arrester. IEC 60099-4 lists five different possible nominal discharge current values: 1.5 kA, 2.5 kA, 5 kA, 10 kA and 20 kA. For distribution arresters the nominal discharge current can be taken as a direct measure of the energy absorption capability. For high-voltage arresters the operating characteristics are not fully described by the nominal discharge current. Further parameters must be considered as well, such as the →[line discharge class](#).

Nominal system voltage: →[Nominal voltage of a system](#)

Nominal voltage of a system: a suitable approximate value of voltage used to designate or identify a system (IEC 60071-1, clause 3.8). Also see →[highest voltage of a system](#), →[highest voltage for equipment](#).

Normal service conditions: According to IEC 60099-4, sub-clause 4.4.1, the following conditions are considered to be normal service conditions:

- Ambient air temperature within the range of -40°C to $+40^{\circ}\text{C}$
- Solar radiation 1.1 kW/m^2
- Altitude not exceeding 1000 m above sea level
- Frequency of the a.c. power supply not less than 48 Hz and not exceeding 62 Hz
- Power-frequency voltage applied continuously between the terminals of the arrester not exceeding the arrester's continuous operating voltage

According to document IEC 37/268/FDIS (Amendment 2 to IEC 60099-4), sub-clause 13.4.1, a wind velocity not exceeding 34 m/s, as well as vertical mounting of the arrester, continue to be normal service conditions. Also see →[abnormal service conditions](#).

Operating duty test: In the operating duty tests (IEC 60099-4, clause 7.5) it is proved that after energy has been injected, the arrester remains →[thermally stable](#) (i.e., cools back down to normal operating temperature) under the conditions of simultaneously occurring →[temporary overvoltage](#). The test parameters are chosen to reflect worst case conditions with regard to possible →[electrical ageing](#) (degradation) of the MO resistors and to the ambient and the operating temperature. The operating duty test may be carried out on →[arrester sections](#), which represent the actual arrester with regard to the electrical and thermal behavior (→ [thermally equivalent prorated section](#)). Distinctions are made between the →[high current impulse operating duty test](#) and the →[switching surge operating duty test](#).

Partial discharge test: This test proves that when a voltage of 1.05 times the →[continuous operating voltage](#) is applied, the arrester is sufficiently free of internal partial discharges. According to the currently applicable IEC 60099-4, Ed. 1.1, 1998-08, "sufficiently free" means a partial discharge level of ≤ 50 pC. In Amendment 2 (document IEC 37/268/FDIS), which is to be published soon as a standard, this value has been reduced to ≤ 10 pC, and the partial discharge test has also become part of the →[type tests](#), while to date it is only defined as a →[routine test](#) and an →[acceptance test](#).

Pi-element: (π -element) A segment of an electrical equivalent circuit is designated as π -element when it is made up of one series element in the line and two parallel elements located in front of it and behind it, which are connected between the line and the ground reference. A power transmission or distribution line can be represented as a series connection of π -elements, whose series elements consist of inductances and whose parallel elements consist of capacitances to earth, see diagram:

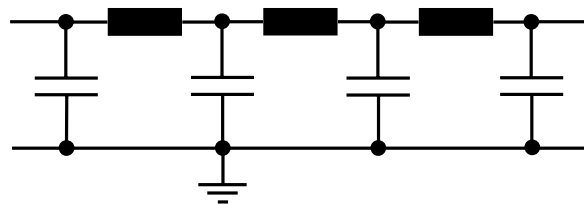

Portland cement: a type of cement which is, for example, used to fix the metal end fittings and flanges of porcelain long-rod and hollow core insulators. Since corrosion appears when in contact with aluminum, an interface layer or coating (e.g., bitumen) must be applied before the embedding if aluminum flanges are used. This can be avoided by using →[sulfur cement](#).

Power-frequency voltage versus time characteristic: (also: U-t-characteristic or V-t-characteristic) representation of the dependency of applied permissible power-frequency voltage on permissible time duration. The voltage is referred to as the root-mean-square value related to the rated or to the continuous operating voltage. The time axis is logarithmically scaled and extends, for example, over a time range of 100 ms to 1000 s. See [Figure 19](#) for an example of a power-frequency voltage versus time characteristic.

Pressure relief class: according to IEC 60099-1, Edition 3, 1991-05, the root-mean-square value of the symmetrical highest short-circuit current (given in kiloamperes, partly also in letters from A to D) which can flow after an arrester has been overloaded, without causing violent shattering of the housing. In the recently published IEC 60099-1, edition 3.1, 1999-12, the pressure relief class has been replaced by the →[rated short-circuit \(withstand\) current](#) (see [tables on page 53](#)). The short-circuit (or pressure relief) behavior is proved by means of the →[short-circuit tests](#) (formerly: pressure relief tests). Also see →[short-circuit withstand \(capability\)](#).

Pressure relief tests: →[Short-circuit tests](#)

Primer: a chemical fluid, which is applied before →[silicone rubber](#) is molded onto other components, and which brings about a strong chemical bonding between the silicone rubber and any other material (aluminum, →[FRP](#), →[MO resistors](#)) after →[vulcanizing](#).

Protective level of an arrester: maximum value of the →[residual voltage](#) of an arrester at a standard →[current impulse](#). In this case there is a difference between the →[lightning impulse protective level](#), the →[switching impulse protective level](#) and the →[steep current impulse protective level](#).

Protective zone of an arrester: An arrester usually has a limited protective zone of only a few meters to up to several ten meters, where the protective zone is defined as the maximum separation distance for which the insulation coordination requirements are fulfilled for a given →[arrester protective level](#) and →[coordination withstand voltage](#) (IEC 60099-5, sub-clause 4.3.1). Arresters, therefore, should be installed as close as possible to the device to be protected. Since →[fast-front overvoltages](#) spread out over the line in the form of →[traveling waves](#), the voltage at the terminals of the device to be protected can be considerably higher than the →[residual voltage](#) of the assigned arrester. The arrester is "effective" only after a time interval, which depends on the propagation rate of the traveling wave and the distance, that is, the propagation time between the arrester and the device to be protected. The steepness of the overvoltage also has a

decisive effect. Generally, the protective level and the location of the arrester must be coordinated in such a way that the →[coordination withstand voltage](#) of the device to be protected is not exceeded. See IEC 60099-5, 60071-1 and 60071-2 for details on the procedure. The protective zone of an arrester, for the simple arrangement of a transformer connected to the end of a single feeder, can be estimated with the use of the following rule-of-thumb formula:

$$x_s = \frac{u_w - u_p}{2 \cdot s} \cdot v$$

with x_s protective zone in m
 u_w standard lightning impulse withstand voltage (BIL) of the device to be protected in kV
 u_p lightning impulse protective level of the arrester in kV
 s front steepness of the lightning overvoltage in kV/ μ s (typical value: 1000 kV/ μ s)
 v propagation speed of a traveling wave in m/ μ s
 (overhead line: $v = c$ (velocity of light) = 300 m/ μ s; cable: $v \approx 150$ m/ μ s)

Accordingly, when considering the connection of the equipment to an overhead line, this roughly results in a maximum protective zone of about 60 m for a solidly earthed 420-kV-system ($u_w = 1425$ kV, $u_p \approx 825$ kV), while for a 24-kV resonant earthed distribution system ($u_w = 125$ kV, $u_p = 80$ kV), the protective zone is only slightly more than four meters! Also, see [Figure 5](#) with the accompanying example.

Push-on method: a method of equipping the →[FRP](#) rods (when manufacturing composite long-rod line insulators) or FRP tubes (when manufacturing →[composite hollow core insulators](#)) with →[silicone rubber](#) sheds. Normally two procedures are common:

- 1) Onto the FRP core a smooth cover out of the same or a similar material as that of the sheds is molded, extruded or shrunken on. After that, pre-manufactured sheds are pushed on. The number of sheds and their distance to each other depends on the creepage path requirements.
- 2) Pre-assembled sheds are pushed directly onto the FRP core. There are no gaps between the sheds, instead they overlap at the ends like shingles.

By using →[primers](#), → interlayers of [RTV silicone rubber](#) and heating it afterwards in an oven, a bonding of the sheds to the core and to each other, respectively, is produced, which is nearly impossible to detach. Designs exist, however, in which the sheds are only pushed on in an expanded condition, and which only because of the mechanical strain remain attached to the core.

Quartz porcelain: a type of porcelain in accordance with subgroup "C 110: siliceous porcelains" of the standard IEC 60672-3.

Ranges of highest voltage for equipment: According to IEC 60071-1, clause 4.8, the standard highest voltages for equipment are categorized into two ranges:

- Range I: $1 \text{ kV} \leq U_m \leq 245 \text{ kV}$
- Range II: $U_m > 245 \text{ kV}$

Rated short-circuit (withstand) current: (symbol: I_s) according to the recently published IEC 60099-1, Ed. 3.1, 1999-12, the root-mean-square value of the symmetrical highest short-circuit current which can flow after an arrester has been overloaded, without causing violent shattering of the housing. Replaces the [→pressure relief class](#) of the earlier edition of the IEC standard, 60099-1, Ed. 3, 1991-05. This behavior is proved by means of the [→short-circuit tests](#) (formerly: pressure relief tests). Also see [tables on page 53](#).

Rated voltage of an arrester: (symbol: U_r) maximum permissible root-mean-square value of power-frequency voltage between the arrester terminals at which it is designed to operate correctly under [→temporary overvoltage](#) conditions as established in the [→operating duty tests](#). Normally, the manufacturer specifies whether it can be applied to the arrester for a duration of 10 seconds (which corresponds to the value in the operating duty test) or 100 seconds. The rated voltage is the reference parameter for determining the operating characteristics (IEC 60099-4, clause 2.8).

Rectangular current impulse: [→Long duration current impulse](#)

Reference current: the peak value of a power-frequency current (in the case of asymmetrical current, the higher peak value of the two polarities), through which the [→reference voltage](#) is ascertained. The reference current is specified by the manufacturer for every MO resistor type, and can be found within a range of about 0.5 mA to 10 mA. It should be selected such that it is large enough for the peak value to clearly be caused by the resistive component in the leakage current, so that the reference voltage reading is not influenced by stray capacitances. An example of a reference voltage reading at reference current can be found under [→reference voltage](#).

Reference voltage: (symbol: U_{ref}) the peak value of power-frequency voltage divided by $\sqrt{2}$ between the arrester terminals while the [→reference current](#) is flowing. The reference voltage is used when choosing a test sample and determining the test parameters for the [→operating duty test](#). In the [→routine test](#) it serves as a simple, indirect proof

that an arrester or an →[arrester unit](#) was assembled in accordance with the residual voltage requirements (the respective residual voltages and the reference voltages form a fixed ratio). The following oscillogram gives an example of a reference voltage reading on an arrester unit during a routine test:

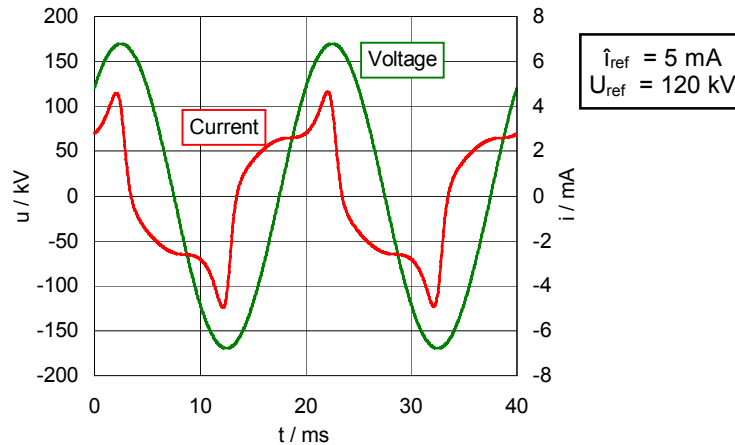

Required withstand voltage: (symbol: U_{rw}) a term from the →[insulation coordination](#): the test voltage that the insulation must withstand in a standard withstand test to ensure an acceptable failure rate (the so-called "performance criterion") in actual service conditions. For an exact definition of the term and its meaning and determination during the process of insulation coordination, see IEC 60071-1 and 60071-2. Also see →[safety factor \$K_s\$](#) .

Residual voltage: (symbol: U_{res} , according to IEC 60099-4) (frequently also called "discharge voltage") the voltage drop between the terminals of the arrester when injecting a →[current impulse](#). For current impulses which have the shape and value of a standard test current impulse (→[lightning current impulse](#), →[switching current impulse](#), →[steep current impulse](#)), the simultaneously occurring residual voltages are the →[protective levels](#) which are assigned to this current shape and value (→[lightning impulse protective level](#), →[switching impulse protective level](#), →[steep current impulse protective level](#)).

Resonant earthed (neutral) system: a system, in which one or more neutral points are earthed through a reactance. As a result the capacitive component of a single-phase-to-earth fault is, for the most part, compensated (which is the reason that the term "compensated system" is also common). With resonant earthing, the residual current in a fault is limited to a value at which a burning arc in the air normally self-extinguishes. (IEC 60071-1, 3.14)

Routine tests: According to IEC 60099-4, MO arresters without gaps must be subjected to at least the following routine tests:

- Measurement of the →[reference voltage](#)
- →[Residual voltage](#) test (on the complete arrester, →[arrester units](#) or samples comprising one or more →[MO resistors](#))
- →[Partial discharge test](#)
- Tightness test
- Current sharing test (in case of multi-column arresters)

RTV silicone rubber: room temperature vulcanizing silicone rubber. A type of silicone rubber which is delivered in a state of low viscosity. It is mixed out of two components in greatly differing quantitative ratios and can be filled into molds without any pressure at process temperatures starting from room temperature. The vulcanizing, however, usually occurs at higher temperatures, in order to reduce the processing time. Increasingly being replaced by →[LSR](#) (or LR).

Safety factor K_s : a factor by which the →[coordination withstand voltage](#) must be multiplied, to obtain the →[required withstand voltage](#) of a device (and, consequently, its →[standard withstand voltage](#)). Stated simply, it is necessary to ensure that no voltage occurs on the terminals of the equipment, that is higher than its standard withstand voltages, divided by the safety factor, K_s . Arresters usually protect non-self-restoring insulations (an exception are, for example, →[line arresters](#)). In these cases $K_s = 1.15$ applies. Thus, for example, to protect a transformer, which has a →[standard lightning impulse withstand voltage](#) of 1425 kV in a system with $U_s = 420$ kV, the →[lightning impulse protective level](#) and the location of the arresters must be chosen, such that at the terminals of the transformer bushings a lightning overvoltage of $1425 \text{ kV} / 1.15 = 1239 \text{ kV}$ is not exceeded. See IEC 60071-1 and 60071-2 for exact definitions of the terms mentioned and how they are determined and applied during the insulation coordination procedure.

Section of an arrester: a complete, suitably assembled part of an arrester which reproduces the behavior of the complete arrester with respect to a particular test. A section of an arrester is not necessarily a →[unit of an arrester](#) (IEC 60099-4, clause 2.5). An example for the section of an arrester is the →[thermally equivalent prorated section](#).

Short-circuit current strength: →[Short-circuit withstand \(capability\)](#)

Short-circuit rating: →[Short-circuit withstand \(capability\)](#)

Short-circuit tests: (previously: pressure-relief tests) On arresters for which the manufacturer claims a →[short-circuit withstand capability](#) (previously: on arresters which are equipped with pressure relief devices), these tests prove, among other things, that the arrester housing is able to withstand short-circuit currents under specified test conditions without causing violent shattering of the housing (an unpressurized, non-explosive breaking is explicitly permitted). To date these tests are not established in the standard IEC 60099-4, but instead only in 60099-1. New test procedures, especially for MO arresters are, however, presently being considered (IEC-document 37/268/FDIS). The pressure relief tests must be carried out for both the high short-circuit current (within the range of 1.5 kA to 80 kA, and for a time duration of 200 ms) and the low short-circuit current (600 A ± 200 A for a time duration of 1 s).

Short-circuit withstand (capability): (also: "short-circuit rating" and "rated short-circuit current" in document 37/268/FDIS) ability of an arrester to withstand the short-circuit current which flows after an overload, without causing violent shattering of the housing. The short-circuit withstand capability is referred to as →[pressure relief class](#), or more recently as →[rated short-circuit \(withstand\) current](#) and proved by means of →[short-circuit tests](#), or pressure relief tests.

SiC resistor: →[Silicon-carbide resistor](#)

SIL: abbreviation for "basic switching impulse insulation level". Even though this term is frequently used when referring to IEC standards, it is only defined by IEEE and ANSI (see standards IEEE Std 1313.1-1996, IEEE Std C62.2-1987, IEEE Std C62.22-1997, ANSI C92.1-1982). The IEC standard 60071-1, Seventh edition, 1993-12, uses the term →[standard switching impulse withstand voltage](#) instead.

Silicon-carbide resistor: (SiC resistor) non-linear resistor, which was used in the arresters before the introduction of →[metal-oxide resistors](#). The non-linearity of its →[voltage-current-characteristic](#) is considerably less pronounced than in a metal-oxide resistor. Thus arresters with silicon-carbide resistors need serial spark gaps, which separate the arrester from the line during continuous operation, and which interrupt the power-frequency follow current which flows through the arrester after a discharge operation.

Silicone rubber: (correct chemical short form: SI, or, depending on the particular type: MQ, VMQ, PMQ, PVMQ; in the literature frequently: SIR). The basic Si-O-Si-O structure with its attached methyl groups (CH₃) is characteristic of silicone rubber:

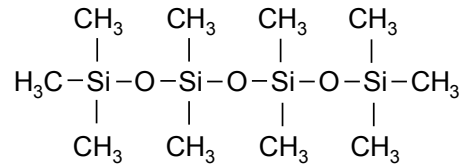

Fillers, such as aluminum trihydrate (ATH) or special additives, affect the tracking and erosion resistance which is needed in high-voltage applications. Not only does silicone rubber provide such important advantages as high elasticity and tear resistance, high temperature resistance (trouble-free application within the temperature range of $-45\text{ }^{\circ}\text{C}$ to $+180\text{ }^{\circ}\text{C}$), flame retardant properties (if burning does occur, only silica acid remains) and high electric field strength, but also the most notable property of silicone rubber, its [→hydrophobicity](#): water simply drips off the silicone surface. This property also transfers to pollution layer films, in that the silicone rubber insulator is water repellent even in heavily polluted conditions, and thus lends the associated devices especially good operating characteristics in polluted environments. The hydrophobicity can indeed decrease when exposed to the long-term effects of moisture or to electric discharge activities; however, after these conditions discontinue, the original water-repellent properties return within a short time (in a few hours or days) – a mechanism, whose effect, as far as is presently known, is interminable. Silicone rubber is processed into three different basic forms: [→HTV silicone rubber](#), [→RTV silicone rubber](#) and [→LSR or LR](#).

Single impulse energy absorption capability: the maximum absorbable energy of an arrester during a single discharge operation. Besides some other influencing factors, it is mainly limited by the maximum allowable thermo-mechanical stress on the ceramic of the MO resistors. If this energy value is exceeded, puncturing, cracking or breaking of the MO resistors may occur (see picture). The single impulse energy absorption capa-



bility is smaller than the [→thermal energy absorption capability](#). Both energies, however, are not stated as such in the IEC standards, and thus are not specified by every manufacturer; and if they are, then frequently under different and incomparable basic conditions. [→Long duration current impulse withstand capability](#) can be considered to be an indirect measure of the single impulse energy absorption capability. According to

IEC 60099-4, however, the energy absorption capability can only be defined by the →[line discharge class](#).

SIR: →[Silicone rubber](#)

Slow-front overvoltage: transient overvoltage, normally unidirectional, with times to peak of 20 μs up to 5000 μs and →[times to half-value on the tail](#) of not more than 20 ms (IEC 60071-1, clause 3.17).

Solidly earthed neutral system: a system within which one or more neutral points are directly connected to the earth (IEC 60071-1, 3.12).

Standard lightning impulse (voltage): a standard test voltage defined in IEC 60060-1, used to prove that the insulation can withstand the stress imposed by →[fast-front overvoltages](#). The standard lightning impulse 1.2/50 has a front time of 1.2 μs and a →[time to half-value on the tail](#) of 50 μs . The following two oscillograms show the standard lightning impulse in two different time resolutions:

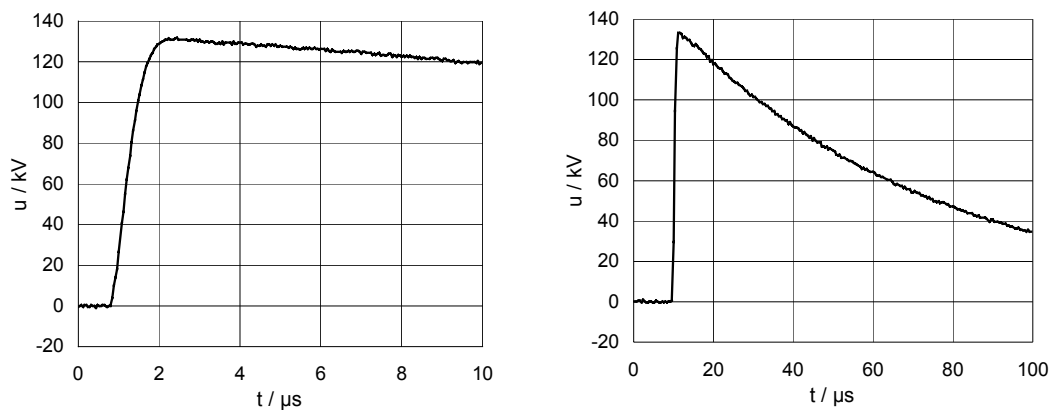

Standard lightning impulse withstand voltage: (also known in American standards as →[BIL](#) for "basic lightning impulse insulation level") a standard value of a lightning impulse test voltage which is used in a standard withstand test to prove that the insulation complies with the required withstand voltage. The different standard lightning impulse withstand voltage values associated with the →[highest voltage for equipment, \$U_m\$](#) , are found in IEC 60071-1, Tables 2 and 3.

Standard switching impulse (voltage): a standard test voltage defined in IEC 60060-1 used to prove that the insulation can withstand the stress imposed by →[slow-front overvoltages](#). The standard switching impulse 250/2500 has a front time of 250 μs and a →[time to half-value on the tail](#) of 2500 μs . The following two oscillograms show the standard switching impulse in two different time resolutions:

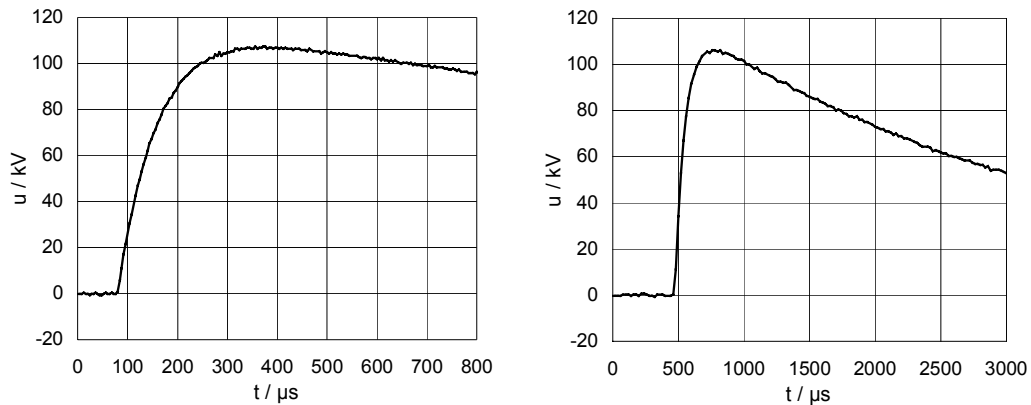

Standard switching impulse withstand voltage: (also known in American standards as \rightarrow [SIL](#) for "basic switching impulse insulation level") a standard value of a switching impulse test voltage which is used in a standard withstand test to prove that the insulation complies with the required withstand voltage. According to IEC 60071-1, standard switching impulse withstand voltages are only specified for \rightarrow [range II](#), that is voltage levels of $U_m > 245$ kV. The different standard switching impulse withstand voltage values associated with the \rightarrow [highest voltage for equipment, \$U_m\$](#) , are found in IEC 60071-1, Table 3.

Standard withstand voltage: (symbol: U_w) a term from the \rightarrow [insulation coordination](#): the standard value of the test voltage applied in a standard withstand test. For an exact definition of the term and its meaning and determination during the process of insulation coordination, see IEC 60071-1 and 60071-2. Also see \rightarrow [safety factor \$K_s\$](#) .

Steep current impulse: \rightarrow [current impulse](#) with a \rightarrow [front time](#) between $0.9 \mu\text{s}$ and $1.1 \mu\text{s}$ and a \rightarrow [time to half-value on the tail](#) of not more than $20 \mu\text{s}$ (IEC 60099-4, clause 2.16). Steep current impulses are used in the laboratory to ascertain the \rightarrow [voltage-current-characteristic](#) of arresters, \rightarrow [arrester sections](#) or \rightarrow [MO resistors](#). They are produced in a low-inductance, frequently coaxial test setup by a practically undamped capacitor discharge into the test sample. The current amplitudes are within a range of 1.5 kA to 20 kA. The following oscillogram depicts an example of a residual voltage measurement on an MO resistor at a steep current impulse of 10 kA:

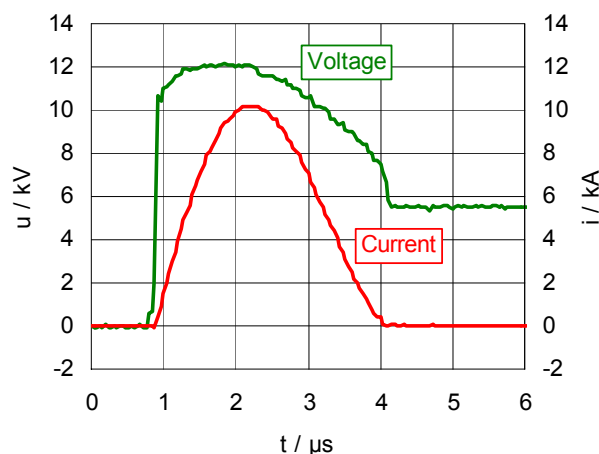

Steep current impulse protective level: maximum value of the →[residual voltage](#) of an arrester at a →[steep current impulse](#) of the same peak value as the →[nominal discharge current](#).

Sulfur cement: a type of cement which, for example, is used to cement metal flanges on porcelain insulators. Sulfur cement consists of about 65 % highly pure sulfur and about 35 % mineral fillers. It is poured at temperatures of about 140 °C and begins to set when the temperature falls below 120 °C. The advantage of sulfur cement over →[Portland cement](#), is, among others, its trouble-free contact with aluminum. The disadvantage is the loss of strength which begins to occur at temperatures above 90 °C. Since these temperatures are not achieved in arrester flanges, sulfur cement is frequently used for arresters.

Surge counter: a device externally fixed to the arrester (see picture below), which has an electromechanical or electronic register to record the number of arrester operations. The surge counter is series-connected with the arrester in its earth connection. This requires installation of the arrester isolated from the ground by means of insulating feet.



Surge impedance: impedance relevant for traveling wave processes on a line. Ignoring the resistive component, the surge impedance results from the inductance and the capacitance per unit length of the line as:

$$Z = \sqrt{\frac{L'}{C'}}$$

with

Z	surge impedance in Ω
L'	inductance per unit length in H/km
C'	capacitance per unit length in F/km

From the equation above it is clear that the surge impedance is not dependent upon the length, that is, it is the same on every location on the line. For high-voltage transmission lines its value is between about 300Ω ($U_s = 800 \text{ kV}$) and 450Ω ($U_s \leq 245 \text{ kV}$) (see IEC 60099-1, Table C.1).

Switching current impulse: peak value of a \rightarrow [current impulse](#) with a \rightarrow [front time](#) of between $30 \mu\text{s}$ and $100 \mu\text{s}$ and a \rightarrow [time to half-value on the tail](#) of roughly double the front time (IEC 60099-4, clause 2.32). Switching current impulses are used in the laboratory to ascertain the \rightarrow [voltage-current-characteristic](#) of arresters, \rightarrow [arrester sections](#) or \rightarrow [MO resistors](#). They are produced by a capacitor discharge in an aperiodically damped RLC circuit. The current amplitudes are within a range of 125 A to 2 kA (see IEC 60099-4, Table 3). The oscillogram depicts an example of a residual voltage measurement on an MO resistor at a switching impulse current of 2 kA :

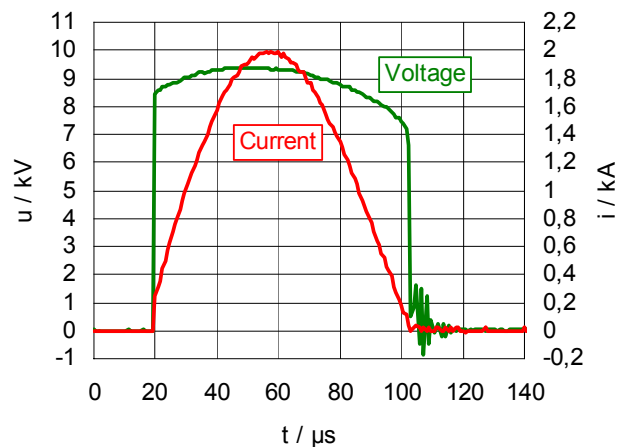

Switching impulse protective level: maximum value of an arrester's \rightarrow [residual voltage](#) at standard \rightarrow [switching current impulses](#). It is listed in each case for two different current impulse peak values within the range of 125 A to 2000 A (IEC 60099-4, Table 3).

Switching impulse residual voltage: \rightarrow [residual voltage](#) of an arrester, \rightarrow [arrester unit](#), \rightarrow [arrester section](#) or \rightarrow [MO resistor](#) at \rightarrow [switching current impulse](#). The switching current impulse peak values are found in IEC 60099-4, Table 3.

Switching overvoltage: transient overvoltage caused by transient phenomena as a result of switching operations or system failures (earth faults, inductive or capacitive switching, load rejection, ferroresonance, etc.). The frequency is within a range of 100 Hz to 10 kHz , and front times occur in the order of magnitude of $30 \mu\text{s}$ to $3000 \mu\text{s}$. The voltage amplitudes can take on between 2 p.u. and 3 p.u. ($1 \text{ p.u.} = \sqrt{2} \cdot U_s / \sqrt{3}$), depending on the system voltage. Switching overvoltage belongs to the \rightarrow [slow-front overvoltages](#), according to IEC 60071-1.

Switching surge operating duty test: see IEC 60099-4, sub-clause 7.5.5. To be carried out on 10-kA-arresters of → [line discharge classes](#) 2 and 3, as well as on 20-kA-arresters of line discharge classes 4 and 5. The sequence is schematically depicted in the following diagram:

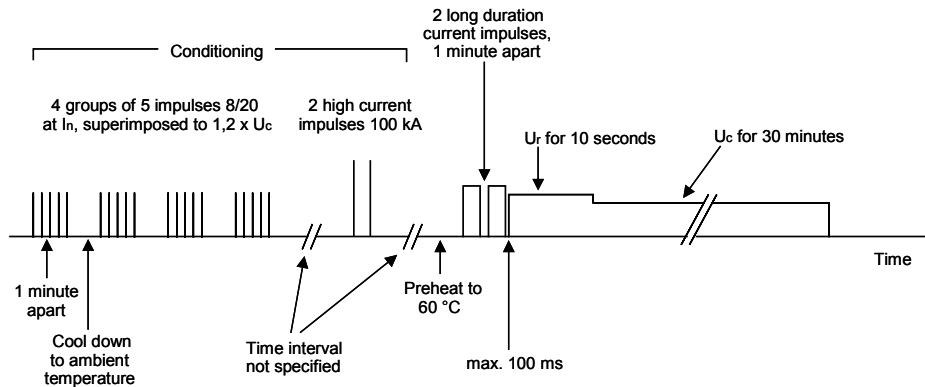

Temporary overvoltage: (abbreviation: TOV) power-frequency overvoltage which can occur for a duration of several tenths of a second to up to a few seconds, as a result of a switching operation or system failure. Its value depends on the type of → [neutral earthing](#) in the system. A special case would involve resonant earthed and isolated neutral systems, in which the phase-to-earth voltage of the healthy phases takes on the value of the phase-to-phase voltage, in case of an earth fault. This operating condition can last for a long time (up to several hours).

Tests: → [Type tests](#), → [Routine tests](#), → [Acceptance tests](#)

Thermal energy absorption capability: maximum amount of energy which can be absorbed by an arrester in the form of several subsequent discharges within a short time interval, without leading to → [thermal instability](#). The thermal energy absorption capability is greater than the → [single impulse energy absorption capability](#). Both energies, however, are not stated as such in the IEC standards, and thus are not specified by every manufacturer; and if they are, then frequently under different and incomparable basic conditions. It makes sense to refer to the → [switching surge operating duty test](#) in this context; in that case the thermal energy absorption capability would be the maximum energy which can be injected into the arrester in the form of two → [long duration current impulses](#), by the procedure, under the conditions and according to the pass criteria of the operating duty test. According to IEC 60099-4, the energy absorption capability is only defined by the → [line discharge class](#).

Thermally equivalent prorated section: (also known as "thermal equivalent") a → [section of an arrester](#) used in the → [operating duty test](#), which reproduces the electri-

cal as well as the thermal behavior of a complete arrester. The requirements on this section are found in IEC 60099-4, sub-clause 7.5.3.2. In principle, a thermally equivalent prorated section is a cutout of the original arrester, whose terminals are so well thermally insulated, that the heat is mostly dissipated radially (as it is the case with the real arrester). The picture shows an example which represents a porcelain housed high-voltage arrester.

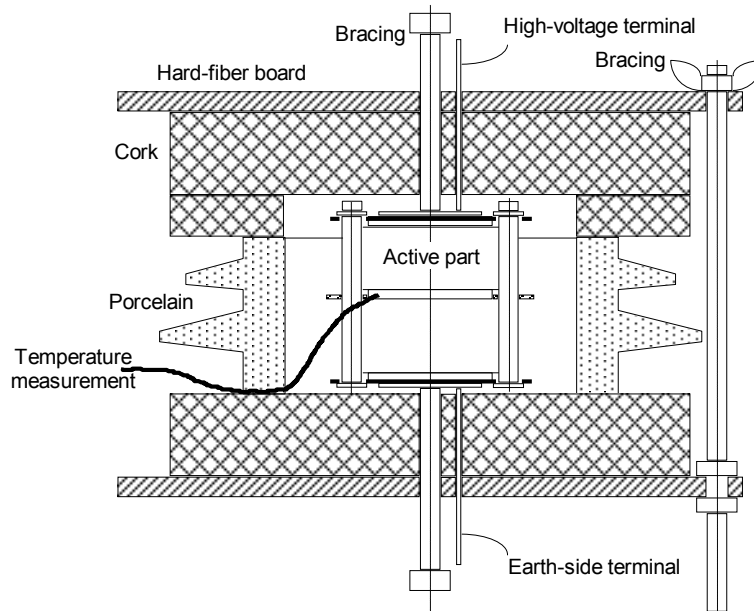

Thermal instability: the (unstable) operating condition of an arrester, which has been heated beyond its →[thermal stability limit](#) by injecting impermissibly high energy, while being connected to power-frequency voltage. If it is not disconnected quickly enough, the arrester heats itself up because of the greatly increased leakage current, until it self-destructs (also known as "thermal runaway").

Thermal model of an arrester: →[Thermally equivalent prorated section](#)

Thermal runaway: →[Thermal instability](#)

Thermal stability limit: highest temperature of the MO resistors, at which an arrester at applied power-frequency voltage and at the highest ambient temperature of +40 °C, as defined by the →[normal service conditions](#), can still cool down to its normal operating temperature. Also see [Figure 7](#) with the accompanying explanation. The values of the thermal stability limit, depending on the actual arrester design, are in the range of 170 °C to about 200 °C.

TLA: →[Line arrester](#)

TLSA: →[Line arrester](#)

Transmission line (surge) arrester: → [Line arrester](#)

Traveling wave: Voltage and current impulses spread as traveling waves on the line when their duration of appearance is shorter than the propagation time of an electromagnetic wave on a line. The amplitudes of the voltage and current waves in this case are linked to each other by the → [surge impedance](#) of the line. According to the rules of traveling wave processes, refraction and reflection occur where the surge impedance of the line changes. This especially can lead to voltage increases (in extreme cases, up to double the amount) and is to be taken into account when determining the protective level of an arrester and its location (→ [protective zone of an arrester](#)).

Type tests: According to IEC 60099-4, MO arresters without gaps are to be subjected to the following type tests:

- Insulation withstand tests on the housing
- → [Residual voltage](#) tests
- → [Long duration current impulse withstand test](#)
- → [Operating duty test](#)
- → [Pressure relief/short-circuit test](#) (still in accordance with IEC 60099-1)
- Artificial pollution test (in accordance with Annex F of IEC 60099-4)
- Current sharing test (only in the case of multi-column arresters)

The following additional requirements apply according to the draft document IEC 37/268/FDIS:

- → [Partial discharge test](#)
- Test of the bending moment
- Environmental tests
- Tightness test

U_c : → [Continuous operating voltage of an arrester](#)

U-I-characteristic: → [Voltage-current-characteristic](#)

U_m : → [Highest voltage for equipment](#)

Unit of an arrester: a completely housed part of an arrester which may be connected in series and/or in parallel with other units to construct an arrester of higher voltage and/or current rating (IEC 60099-4, clause 2.6).

U_r : → [Rated voltage of an arrester](#)

U_{ref} : → [Reference voltage](#)

U_{rw} : → [Required withstand voltage](#)

U_s : → [Highest voltage of a system](#)

U-t-characteristic: → [Power-frequency voltage versus time characteristic](#)

U_w : → [Standard withstand voltage](#)

Vacuum-impregnated FRP tube: implementation of an → [FRP](#) tube which is manufactured by impregnating the previously wound dry fiber-glass construction in resin, under vacuum conditions. By using this manufacturing process, total absence of voids can be achieved (thus eliminating the risk of internal partial discharges and related deterioration effects, even under highest electric fields stress conditions), as well as high bending strength, when the glass fibers are mostly orientated in axial direction, which is not possible with the → [wet-process](#). This type of manufacturing is, however, more expensive than the wet-process.

Very-fast-front overvoltage: transient overvoltage, normally unidirectional, with time to peak not greater than 0.1 μ s, a total duration below 3 ms, and with superimposed oscillations at a frequency between 30 kHz and 100 MHz (IEC 60071-1, clause 3.17).

V-I-characteristic: → [Voltage-current-characteristic](#)

Virtual front time of a current impulse (T_1): the time in microseconds equal to 1.25 the time in microseconds for the current to increase from 10 % to 90 % of its peak value (IEC 60099-4, clause 2.23).

Virtual time to half-value on the tail of an impulse (T_2): the time interval between the virtual origin of the impulse and the instant in which the voltage or the current has decreased to half of its peak value; expressed in microseconds (IEC 60099-4, clause 2.25).

Voltage-current-characteristic: (also: U-I-characteristic or V-I-characteristic) representation of the dependency of arrester voltage on current. Usually the voltage peak values are on the ordinate, frequently with values related to the → [lightning impulse protective level](#). The current peak values (resistive component only) are on the abscissa, represented logarithmically and within a range of several decades of magnitude (e.g. from 10 μ A to 100 kA). See [Figure 2](#) for an example of a voltage-current characteristic.

V-t-characteristic: → [Power-frequency voltage versus time characteristic](#)

Vulcanization: cross-linking of the individual molecule chains of a polymer material to a three-dimensional network. The cross-linked material is often designated with an additional "XL". Example: the thermoplastic polyethylene (PE) becomes thermo-elastic cross-linked polyethylene (XLPE).

Wet-processed FRP tube: →[FRP](#) tube, which is manufactured by winding up resin impregnated fiber-glass rovings on a core. This production process requires that the glass fibers can only be set up diagonally (thus, for example, not exactly in the direction of the core axis, as is possible with →[vacuum-impregnated FRP tubes](#)). As a result the achievable bending strength usually remains below that of a similarly dimensioned vacuum-impregnated tube when the direction of the glass fibers is mostly in axial direction. In addition, voids cannot totally be avoided; these can cause dielectric and ageing problems under extremely high electric field stress in service (risk of internal partial discharges; however, the critical electric field stress is never achieved when the FRP tubes are used for the composite housings of outdoor arresters). Wet-processed tubes are easier to manufacture than vacuum-impregnated tubes.

Withstand voltage: the value of the test voltage to be applied under specified conditions in a withstand test, during which a specified number of disruptive discharges is tolerated (IEC 60071-1, clause 3.23; see there also for additional details).

ZnO resistor: →[MO resistor](#)



SIEMENS

More info?

If you have further questions about our surge arresters, please call us. We will be happy to provide you with any information you may need.
Tel. +49 (0)30 - 386 2 30 61
Fax +49 (0)30 - 386 2 67 21
e-mail: arrester@siemens.de

Siemens AG
Power Transmission and Distribution
High Voltage Division
Surge Arresters
Nonnendammallee 104
13629 Berlin
Germany

Phone: +49 (0)30 386-23061
Mail: arrester@siemens.de